

**EN** Set Up Instructions

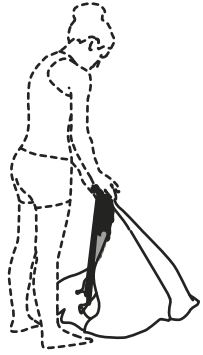

Remove any rocks, branches and other sharp objects from the area you will lay on. Spread the shader evenly on the ground.

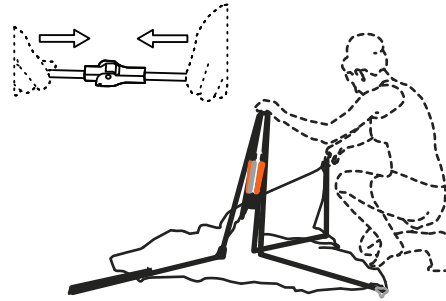

With the hub in an upright position, unfold the poles and lock the joints.

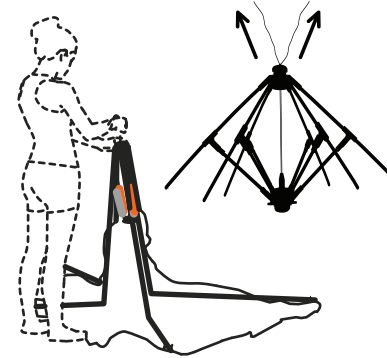

Standing behind the shader, grab the top orange drawstrings, one in each hand.

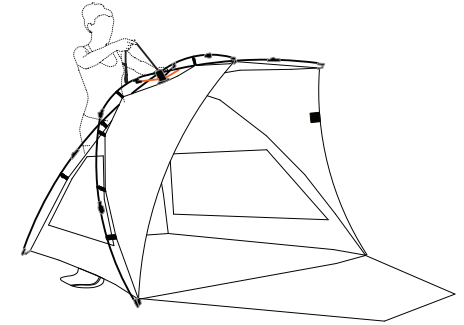

Pull the drawstrings firmly until the upper and lower parts of the hub connect, and the shader takes its final shape.

**Tip:**

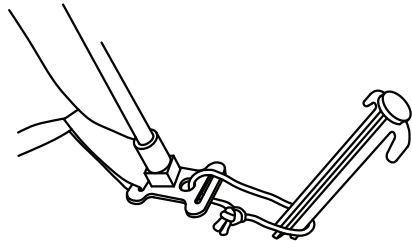

Fasten the shader to the ground by inserting the included pegs through the appropriate loop found at the end of each pole.

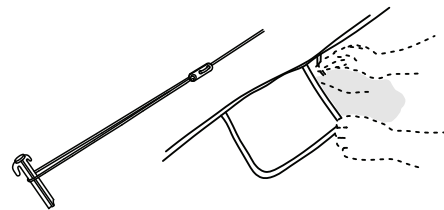

For extra stability, fasten the shader to the ground using the outer cords and fill with sand or pebbles the peripheral outer pockets.

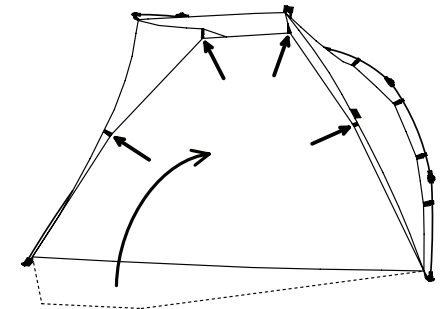

For extra privacy or when away from the shader, fold the ground sheet and hang it on the appropriate hooks found on the shader's flysheet.

**EN** Collapse Instructions

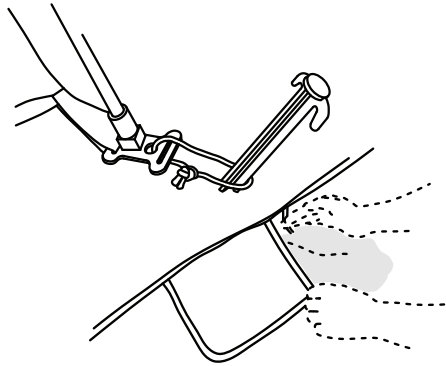

Remove all the pegs and empty the peripheral pockets.

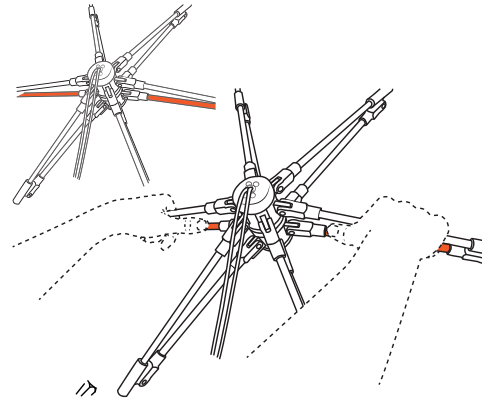

Standing behind the shade, grab the left and right poles and place your thumbs on the underlying orange ones.

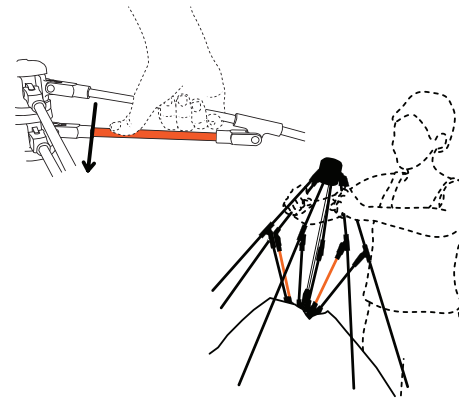

Using your thumbs, push the orange poles downwards to disengage the hub and collapse the shade.

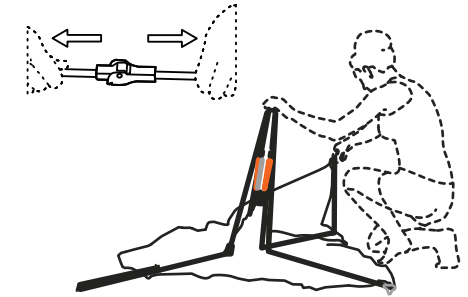

Unlock the joints and fold the poles onto themselves.



Wreathe the exceeding fabric around the hub and place the shade in the carry bag.

## Maintenance and Storage

- Only water should be used when cleaning the fabrics.
- The stains should be treated locally and separately.
- The beach shade must be dry and clean before storing.
- Pegs should be stored in their case.
- Select a dry and shady place to store the beach shade.