



MORRIS

B72206ETD



REFRIGERATOR
USER MANUAL

Please read this manual carefully before use this product

CONTENT

1. Safety Warnings

1.1 Warning	1-2
1.2 Meaning of the safety warning symbols	3
1.3 Electricity related warnings	3
1.4 Warnings for using	4
1.5 Warnings for placement	4-5
1.6 Warnings for energy	5
1.7 Warnings for disposal	5

2. Proper use of the refrigerator

2.1 Placement	6
2.2 Levelling feet	7
2.3 Changing the light	8
2.4 Starting	8
2.5 Energy Saving Tips	8

3. Structure & functions

3.1 Key components	9
3.2 Operation	10

4. Maintenance & Care

4.1 Overall cleaning	11
4.2 Defrosting	11
4.3 Out of operation	11

5. Troubleshooting

6. Parameters

1.1 Warnings



Warning: risk of fire / flammable materials

This appliance is intended to be used in household and similar applications such as staff kitchen areas in shops, offices and other working environments; farm houses and by clients in hotels, motels and other residential type environments; bed and breakfast type environments; catering and similar non-retail applications.

If the supply cord is damaged, it must be replaced by the manufacturer, its service agent or similarly qualified persons in order to avoid a hazard.

Do not store explosive substances such as aerosol cans with flammable propellant in this appliance.

The appliance has to be unplugged after use and before carrying out user maintenance on the appliance.

WARNING: Keep ventilation openings, in the appliance enclosure or in the built-in structure, clear of obstructions.

WARNING: Do not use mechanical devices or other means to accelerate the defrosting process, other than those recommended by the manufacturer.

WARNING: Do not damage the refrigerant circuit.

WARNING: Do not use electrical appliances inside the food storage compartments of the appliance, unless they are of the type recommended by the manufacturer.

WARNING: Please abandon the refrigerator according to local regulations for products that use flammable blowing gas and refrigerant.

WARNING: When positioning the appliance, ensure the supply cord is not trapped or damaged.

WARNING: Do not locate multiple portable socket-outlets or portable power supplies at the rear of the appliance.

Do not use extension cords or ungrounded (two prong) adapters.

DANGER: Risk of child entrapment. Before you throw away your old refrigerator or freezer:

- Take off the doors.

- Leave the shelves in place so that children may not easily climb inside.

The refrigerator must be disconnected from the source of electrical supply before attempting the installation of accessory.

Refrigerant and cyclopentane foaming material used for the refrigerator are flammable. Therefore, when the refrigerator is scrapped, it shall be kept away from any fire source and be recovered by a special recovering company with corresponding qualification other than be disposed by combustion, so as to prevent damage to the environment or any other harm.

For EN standard: This appliance can be used by children aged from 8 years and above and persons with reduced physical sensory or mental capabilities or lack of experience and knowledge if they have been given supervision or instruction concerning use of the appliance in a safe way and understand the hazards involved. Children shall not play with the appliance. Cleaning and user maintenance shall not be made by children without supervision. Children aged from 3 to 8 years are allowed to load and unload refrigerating appliances.

Children should be supervised to ensure that they do not play with the appliance.

The instructions shall include the substance of the following: To avoid contamination of food, please respect the following instructions:

- Opening the door for long periods can cause a significant increase of the temperature in the compartments of the appliance.
- Clean regularly surfaces that can come in contact with food and accessible drainage systems.
- Clean water tanks if they have not been used for 48 hours; flush the water system connected to a water supply if water has not been drawn for 5 days (note 1).
- Store raw meat and fish in suitable containers in the refrigerator, so that it is not in contact with or drip onto other food.
- Two-star ** frozen-food compartments are suitable for storing pre-frozen food, storing or making ice cream and making ice cubes (note 2).
- One * - two ** - and three *** star compartments are not suitable for the freezing of fresh food (note 3).
- For appliances without a 4-star compartment: this refrigerating appliance is not suitable for freezing foodstuffs (note 4)
- If the refrigerating appliance is left empty for long periods, switch off, defrost, clean, dry and leave the door open to prevent mould developing within the appliance.

Note 1, 2, 3, 4: Please confirm whether it is applicable to your product compartment type.

For a freestanding appliance: this refrigerating appliance is not intended to be used as a built-in appliance.

Any replacement or maintenance of the LED lamps is intended to be made by the manufacturer, its service agent or similar qualified person

1.2 Meaning of safety warning symbols



Prohibition symbol

This is a prohibition symbol.
Any inobservance with instructions marked with this symbol may result in damage of the product or endanger the personal safety of the user.



Warning symbol

This is a warning symbol.
It is required to operate in strict observance of instructions marked with this symbol or otherwise damage to the product or personal injury may be caused.



Note symbol

This is a cautioning symbol.
Instructions marked with this symbol require special caution. Insufficient caution may result in slight or moderate injury or damage to the product.

This manual contains lots of important safety information which shall be observed by users.

1.3 Electricity related warnings

		<p>Do not pull the power cord when pulling the power plug of the refrigerator. Please firmly grasp the plug and pull it out from the socket directly</p> <p>To ensure safe use, do not damage the power cord. Do not use the power cord when it is damaged or worn.</p>
--	--	---

<p>Please use a dedicated power socket and the power socket shall not be shared with other electrical appliances. The power plug should be firmly contacted with the socket or else fires might be caused.</p> <p>Please ensure that the grounding electrode of the power socket is equipped with a reliable grounding line.</p>	
--	--

		<p>Please turn off the valve of the leaking gas and then open the doors and windows in case of leakage of gas and other flammable gases. Do not unplug the refrigerator and other electrical appliances considering that spark may cause a fire.</p>
--	--	--

<p>Do not use electrical appliances on the top of the appliance unless they are of the type recommended by the manufacturer.</p>	
--	--

1.4 Warnings for using

⊗

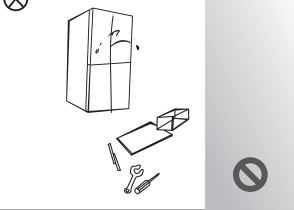

Do not arbitrarily disassemble or reconstruct the refrigerator, nor damage the refrigerant circuit; maintenance of the appliance must be conducted by a specialist.

Damaged power cord must be replaced by the manufacturer, its maintenance department or related professionals in order to avoid danger.

The gaps between refrigerator doors and between doors and refrigerator body are small, be noted not to put your hand in these areas to prevent from squeezing your fingers. Please be gentle when close the refrigerator door to avoid falling objects.

Do not pick foods or containers with wet hands in the freezing chamber when the refrigerator is running, especially metal containers in order to avoid frostbite.

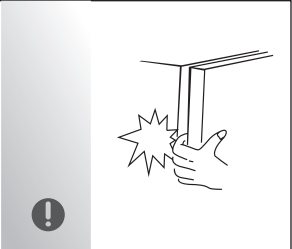

⊗



Do not allow any child to get into or climb the refrigerator; otherwise suffocation or falling injury for the child may be caused.

Do not place heavy objects on the top of the refrigerator considering that objects may fall when close or open the door, and accidental injuries might be caused.

Please pull out the plug in case of power failure or cleaning. Do not connect the refrigerator to power supply within five minutes to prevent damages to the compressor due to successive starts.

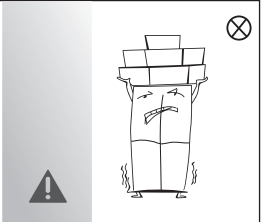

1.5 Warnings for placement

⊗

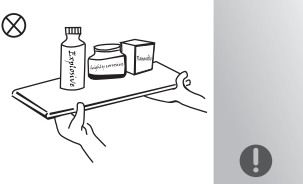

Do not put flammable, explosive, volatile and highly corrosive items in the refrigerator to prevent damages to the product or fire accidents.

Do not place flammable items near the refrigerator to avoid fires.

The refrigerator is intended for household use such as storage of foods. It shall not be used for other purposes such as storage or blood, drugs or biological products etc.

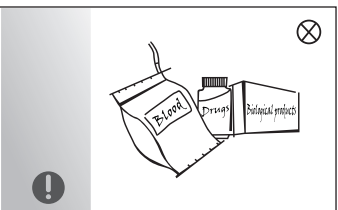

Freezing chamber



Do not store beer, beverage or other fluid contained in bottles or enclosed containers in the freezing chamber of the refrigerator otherwise the bottles or enclosed containers may crack due to freezing to cause damages.



1.6 Warnings for energy



- Refrigerating appliances might not operate consistently (possibility of defrosting of contents or temperature becoming too warm in the frozen food compartment) when sited for an extended period of time below the cold end of the range of temperatures for which the refrigerating appliance is designed.
- Effervescent drinks should not be stored in food freezer compartments or cabinets or in low-temperature compartments or cabinets. Some products such as water ices should not be consumed too cold.
- It is important to not exceed the storage time(s) recommended by the food manufacturers for any kind of food and particularly for commercially quick-frozen food in food-freezer and frozen-food storage compartments or cabinets.
- Take necessary precautions to prevent an undue rise of the temperature of the frozen food while defrosting the refrigerating appliance, such as wrapping the frozen food in several layers of newspaper.
- A rise in temperature of the frozen food during manual defrosting, maintenance or cleaning could shorten the storage life.
- It is necessary, for doors or lids fitted with locks and keys, the keys to be kept out of the reach of children and not in the vicinity of the refrigerating appliance, in order to prevent children from being locked inside.

1.7 Warnings for disposal



Refrigerant and cyclopentane foaming material used for the refrigerator are flammable. Therefore, when the refrigerator is scrapped, it shall be kept away from any fire source and be recovered by a special recovering company with corresponding qualification other than be disposed by combustion, so as to prevent damage to the environment or any other harm.

Before you scrap the refrigerator, disassemble the doors and remove gasket of door and shelves; put the doors and shelves in a proper place so as to prevent entrapment of a child.

Correct disposal of this product:

This marking indicates that this product should not be disposed with other household wastes. To prevent possible harm to the environment or human health from uncontrolled waste disposal, recycle it responsibly to promote the sustainable reuse of material resources. To return your used device, please use the return and collection systems or contact the retailer where the product was purchased. They can take this product for environmental safe recycling.

2.1 Placement



Before use, remove all packing materials, including bottom cushions, foam pads and tapes inside of the refrigerator. Tear off the protective film on the doors and the refrigerator body.

Keep away from heat and avoid direct sunlight. Do not place the freezer in moist or watery places to prevent rust or reduction of insulating effect.

Do not spray or wash the refrigerator. Do not put the refrigerator in moist places easy to be splashed with water so as not to affect the electrical insulation properties of the refrigerator.

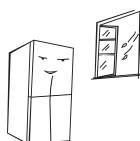

The refrigerator is placed in a well-ventilated indoor place. The ground shall be flat and sturdy (rotate left or right to adjust the wheel for levelling if unstable).

The top space of the refrigerator shall be greater than 30cm and the refrigerator should be placed against a wall with a free distance more than 10cm to facilitate heat dissipation.

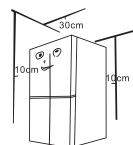

Minimum distance from heat resources:
 From the electric gas and other ovens: 30mm
 From oil or coil fired ovens: 300mm
 From built-in ovens: 50mm.

If there is no possibility of ensuring the above mentioned distances, provide an appropriate insulation board.

Precautions before installation:
 Before installation or adjusting of accessories, it shall be ensured that the refrigerator is disconnected from power.
 Precautions shall be taken to prevent fall of the handle from causing any personal injury.

2.2 Levelling feet

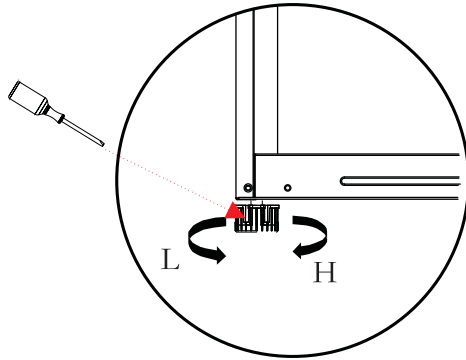

- 1 Turn the feet clockwise to raise the refrigerator.
- 2 Turn the feet counterclockwise to lower the refrigerator.
- 3 Adjust the right and left feet based on the procedures above to a horizontal level.

2.3 Changing the Light (optional)

Any replacement or maintenance of the LED lamps is intended to be made by the manufacturer, its service agent or similar qualified person.

2.4 Starting

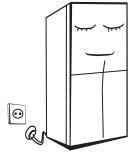

Before initial start, keep the refrigerator still for two hours before connecting it to power supply.

Before putting any fresh or frozen foods, the refrigerator shall have run for 2-3 hours, or for above 4 hours in summer when the ambient temperature is high.

Spare enough space for convenient opening of the doors and drawers or statement by the distributor.

2.5 Energy saving tips

 The appliance should be located in the coolest area of the room, away from heat producing appliances or heating ducts, and out of the direct sunlight.

Let hot foods cool to room temperature before placing in the appliance. Overloading the appliance forces the compressor to run longer. Foods that freeze too slowly may lose quality, or spoil. 

 Be sure to wrap foods properly and wipe containers dry before placing them in the appliance. This cuts down on frost build-up inside the appliance.

Appliance storage bin should not be lined with aluminum foil, wax paper or paper toweling. Liners interfere with cold air circulation, making the appliance less efficient. 

 Organize and label food to reduce door openings and extended surfaces. Remove as many items as needed at one time and close the door as soon as possible

3.1. Key components

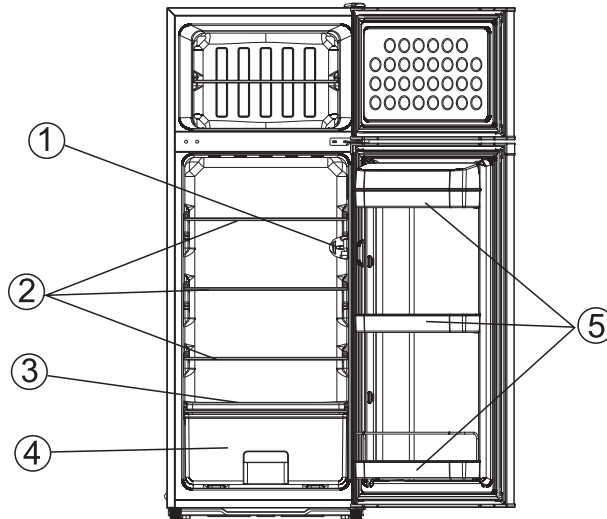

1. Temperature regulator
2. Storage shelves
3. Crisper cover
4. Crisper
5. Door shelves (eggs tray inside the upper shelves)

(The picture above is only for reference.

The actual configuration will depend on the physical product or statement by the distributor).

Refrigerating chamber

- The refrigerating chamber is suitable for storage of a variety of fruits, vegetables, beverages and other food consumed in a short term. Suggested storage time 3 to 5 days.
- Cooked food shall not be put in the refrigerator chamber until cooled to room temperature.
- Foods are recommended to be sealed up before putting into the refrigerator.
- The glass shelves can be adjusted up or down for a reasonable amount of storage space and easy use.

Freezing chamber

- The low temperature freezing chamber may keep food fresh for a long time and it is mainly used to store frozen foods and making ice.
- The freezing chamber is suitable for storage of meat, fish, rice balls and other food not to be consumed in a short term.
- Chunks of meat are preferably to be divided into small pieces for easy access. Please be noted food shall be consumed within the shelf time.
- The temperature should be set to "super freezing" when you want to refrigerate foods quickly.
- Store fresh packed items on the glass shelves, fresh fruits and vegetable in the veget. box.
- Place bottles in the door storage racks
- With air circulation different climate zone arises.
- The coldest zone is located at the rear and the lower fridge part. Recommended for the storage of foods such as fish, sausages and meat.
- The warmest zone is located at the door and the upper fridge part. Suitable for the storage of e.g cheese and butter.

Drawers, food boxes, shelves etc placed according to the position in the picture above are the most energy efficient

Note: Storage of too much food during operation after the initial connection to power may adversely affect the freezing effect of the refrigerator. Foods stored shall not block the air outlet; otherwise the freezing effect will also be adversely affected.

3.2. Operation

When operating for the first time, set the thermostatic dial at 3, connect the electric wire and run it without loading any food. Usually it takes 2 or 3 hours. Then set the thermostatic dial at the desired setting and place foods into the refrigerator.

The temperature of the refrigerator can be adjusted by turning the regulator knob. 3-4 setting is the most suitable for general operation. The thermostatic dial number higher, the refrigeration capability stronger.

Do not put too many foods in the refrigerator. Do not open the door frequently in order to maintain the temperature of the refrigerator and save energy.

When making ice cubes, fill the ice making case with drinking water and put it into the freezer. It takes about 2 or 3 hours to make ice cubes. Pieces of ice cube can be removed by twisting it. Do not press it up and down, otherwise it may be broken.

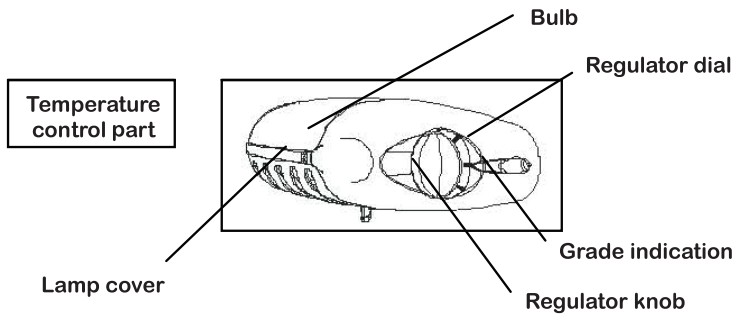
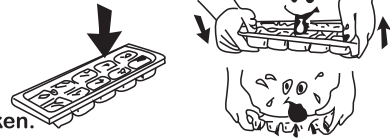

4.1 Overall cleaning

- Dusts behind the refrigerator and on the ground shall be timely cleaned to improve the cooling effect and energy saving.
- Check the door gasket regularly to make sure there are no debris. Clean the door gasket with a soft cloth dampened with soapy water or diluted detergent.
- The interior of the refrigerator should be cleaned regularly to avoid odor.
- Please turn off the power before cleaning interior, remove all foods, drinks, shelves, drawers etc.
- Use a soft cloth or sponge to clean the inside of the refrigerator, with two tablespoons of baking soda and a quarter of warm water. Then rinse with water and wipe clean. After cleaning, open the door and let it dry naturally before turning on the power.
- For areas that are difficult to clean in the refrigerator (such as narrow channels, gaps or corners) it is recommended to wipe them regularly with a soft rag, soft brush etc. and when necessary, combined with some auxiliary tools (such as thin sticks) to ensure no contaminants or bacterials accumulation in these areas.
- Do not use soap, detergent, scrub powder, spray cleaner etc. as these may cause odors in the interior of the refrigerator or contaminated food.
- Clean the bottle frame, shelves and drawers with a soft cloth dampened with soapy water or diluted detergent. Dry with a soft cloth or dry naturally.
- Wipe the outer surface of the refrigerator with a soft cloth dampened with soapy water or diluted detergent and then wipe dry.
- Do not use hard brushes, clean steel balls, wire brushes, abrasives (such as toothpastes), organic solvents (such as alcohol, acetone, banana oil etc.), boiling water, acid or alkaline items which may damage the fridge surface and interior. Boiling water and organic solvents such as benzene may deform or damage plastic parts
- Do not rinse directly with water or other liquids during cleaning to avoid short circuits or affect electrical insulation after immersion.



 Please unplug the refrigerator for defrost and cleaning.

4.2 Defrosting

Refrigerator can defrost automatically. Defrost the freezer whenever the layer of frost on the surface reaches 3 or 4 mm. When defrosting, remove all foods and accessories, set the thermostat at 0 position and open the door. After the frost has melted, discard the water and dry up the interior of the refrigerator. The refrigerator can then be restarted by turning its thermostat to the desired setting.

4.3 Out of operation



Power failure: In case of power failure, even if it is summer, foods inside the appliance can be kept for several hours. During the power failure, the times of door opening shall be reduced and no more fresh food shall be put into the appliance

Moving: Before the refrigerator is moved, take all objects inside out, fix the glass partitions, vegetable holder, freezing chamber drawers etc with tape and tighten the levelling feet. Close the doors and fix them with tape. During moving, the appliance shall not be laid upside down or horizontally or be vibrated; the inclination during movement shall be no more than 45°



The appliance shall run continuously once it is started. Generally, the operation of the appliance shall not be interrupted; otherwise the service life may be impaired

You may try to solve the following simple problems by yourself. If they cannot be solved, please contact the after-sales department.



Failed operation	<ul style="list-style-type: none"> - Check whether the appliance is connected to power or whether the plug is in well contact. - Check whether the voltage is too low. - Check whether there is a power failure or partial circuits have tripped.
Odor	<ul style="list-style-type: none"> - Odorous foods shall be tightly wrapped. - Check whether there is any rotten food. - Clean the inside of the refrigerator.
Long-time operation of the compressor	<ul style="list-style-type: none"> - Long operation of the refrigerator is normal in summer when the ambient temperature is high. - It is not recommended having too much food in the appliance at the same time. - Food shall get cool before being put into the appliance. - The doors are opened too frequently.
Light fails to get lit	Check whether the refrigerator is connected to power supply and whether the illuminating light is damaged.
Doors cannot be properly closed	<ul style="list-style-type: none"> - The door is stuck by food packages. - The refrigerator is tilted.
Loud noise	<ul style="list-style-type: none"> - Check whether the floor is level and the refrigerator is placed stable. - Check whether accessories are placed at proper locations.
Door seal fails to be tight	<ul style="list-style-type: none"> - Remove foreign materials from the door seal. - Heat the door seal and then cool it for restoration (blow with an electrical dryer or use a hot towel for heating).
Water pan overflows	<ul style="list-style-type: none"> - There is too much food in the chamber or stored food contains too much water, resulting in heavy defrosting. - The doors are not closed properly, resulting in frosting due to entry of air and increased water due to defrosting.
Hot housing	Heat dissipation of the built-in condenser via the housing, which is normal. When housing becomes hot due to high ambient temperature and storage of too much food, it is recommended to provide sound ventilation to facilitate heat dissipation.
Surface condensation	Condensation of the exterior surface and door seals of the refrigerator is normal when the ambient humidity is too high. Just wipe the condensate with a clean towel.
Abnormal noise	<ul style="list-style-type: none"> - Buzz: the compressor may produce sound during operation sometimes loud, particularly upon start or stop. This is normal. - Creak: refrigerant flowing inside of the appliance may produce creak. This is normal.

Table 1 Climate classes

Class	Symbol	Ambient temperature range °C
Extended temperate	SN	+10 to +32
Temperate	N	+16 to +32
Subtropical	ST	+16 to +38
Tropical	T	+16 to +43

Extended temperate: this refrigerating appliance is intended to be used at ambient temperatures ranging from +10°C up to +32°C

Temperate: this refrigerating appliance is intended to be used at ambient temperatures ranging from +16°C up to +32°C

Subtropical: this refrigerating appliance is intended to be used at ambient temperatures ranging from +16°C up to +38°C

Tropical: this refrigerating appliance is intended to be used at ambient temperatures ranging from +16°C up to +43°C

The ordered parts in the following table can be acquired from Channel:

AMIRIDIS - SAVVIDIS S.A.
87A, 17th November str
55535, Pylea, Thessaloniki
Tel: +302310944944

Ordered parts	Provided by	Minimum time required for provision
thermostats	Professional maintenance personnel	At least 7 years after the last model is launched on the market
temperature sensors	Professional maintenance personnel	At least 7 years after the last model is launched on the market
printed circuit boards	Professional maintenance personnel	At least 7 years after the last model is launched on the market
light sources	Professional maintenance personnel	At least 7 years after the last model is launched on the market
door handles	Professional maintenance personnel and final users	At least 7 years after the last model is launched on the market
door hinges	Professional maintenance personnel and final users	At least 7 years after the last model is launched on the market
trays	Professional maintenance personnel and final users	At least 7 years after the last model is launched on the market
baskets	Professional maintenance personnel and final users	At least 7 years after the last model is launched on the market
door gaskets	Professional maintenance personnel and final users	At least 10 years after the last model is launched on the market

Product Information Sheet

COMMISSION DELEGATED REGULATION (EU) 2019/2016

Supplier's name or trademark: MORRIS

Supplier's address: 17th November str 87A, 55534 Thessaloniki Pylea, Thessaloniki Thessaloniki, EL

Model identifier: B72206ETD

Type of refrigerating appliance:

Low-noise appliance:	No	Design type:	freestanding
Wine storage appliance:	No	Other refrigerating appliance:	Yes

General product parameters:

Parameter		Value	Parameter	Value
Overall dimensions (millimetre)	Height	1410	Total volume (dm ³ or l)	206
	Width	550		
	Depth	570		
EEL		100	Energy efficiency class	E
Airborne acoustical noise emissions (dB(A) re 1 pW)		39	Airborne acoustical noise emission class	C
Annual energy consumption (kWh/a)		180	Climate class:	temperate, subtropical,
Minimum ambient temperature (°C), for which the refrigerating appliance is suitable		16	Maximum ambient temperature (°C), for which the refrigerating appliance is suitable	38
Winter setting		No		

Compartment Parameters:

Compartment type	Compartment parameters and values				
	Compartment volume (dm ³ or l)	Recommended temperature setting for optimised food storage (°C) These settings shall not contradict the storage conditions set out in Annex IV, Table 3	Freezing capacity (kg/24h)	Defrosting type (auto-defrost=A, manual defrost=M)	
Pantry	No	-	-	-	-
Wine storage	No	-	-	-	-
Cellar	No	-	-	-	-
Fresh food	Yes	162.0	4	-	M

Chill	No	-	-	-	-
0-star or ice-making	No	-	-	-	-
1-star	No	-	-	-	-
2-star	No	-	-	-	-
3-star	No	-	-	-	-
4-star	Yes	44.0	-18	2.0	M
2-star section	No	-	-	-	-
Variable temperature compartment	-	-	-	-	-
For 4-star compartments					
Fast freeze facility			No		
Light source parameters:					
Type of light source			Lighting technology used: LED		
Energy efficiency class			E		
Minimum duration of the guarantee offered by the manufacturer: 24 months					
Additional information:					
Weblink to the manufacturer's website, where the information in point4(a) Annex of Commission Regulation (EU) 2019/2019 is found: www.morris.gr					

IMPORTANT

NOTICE ABOUT RECYCLING

Your product is designed and manufactured with high quality materials and components which can be recycled and reused. This symbol means that electrical and electronic equipment, at their end of life, should be disposed of separately from your household waste. Please dispose of this equipment at your local community waste collection/recycling centre.



In the European Union there are separate collection systems for used electrical and electronic products. Please help to preserve the environment we live in!

DECLARATION OF CONFORMITY

Herewith we state that this product, complies with the requirements of below directives:

EMC Directive: 14/30/EU

Low Voltage Directive: 14/35/EU

ErP Directive: 09/125/EC

CE Marking: 93/68/EEC

ROHS Directive: 11/65/EU & Delegating Directive 15/863/EU

The detailed declaration of conformity can be found at www.morris.gr



IMPORTER:
Kalliopi Karyda & Co, LP
87A, 17th November str.
55535, Pylea, Thessaloniki
Tel. 2316 006600
Fax. 2316 006650
www.morris.gr