

# VM2251 Video Baby Monitor



## vtech User's manual

### CONGRATULATIONS

on purchasing your new VTech product. Before using this product, please read **Important safety instructions**.

This manual has all the feature operations and troubleshooting necessary to install and operate your new VTech product. Please review this manual thoroughly to ensure proper installation and operation of this innovative and feature-rich VTech product.

### WHAT'S IN THE BOX

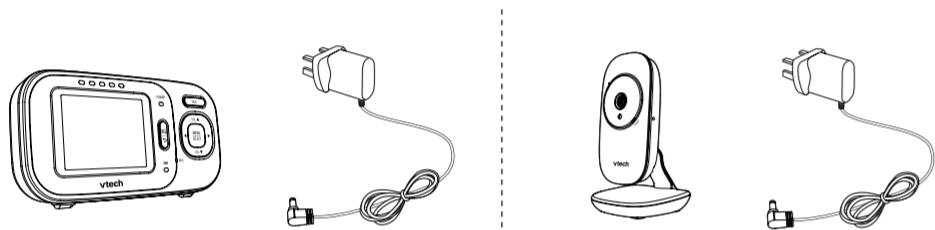

Specifications are subject to change without notice.  
© 2021 Vtech Telecommunications Ltd.  
All rights reserved. 02/21, VM2251, UK, C18, V6



## IMPORTANT SAFETY INSTRUCTIONS

The applied nameplate is located at the bottom of the baby unit's base.

When using your equipment, basic safety precautions should always be followed to reduce the risk of fire, electric shock and injury, including the following:

- Follow all warnings and instructions marked on the product.
- Adult setup is required.
- CAUTION:** Do not install the baby unit at a height above 2 metres.
- This product is intended as an aid. It is not a substitute for responsible and proper adult supervision and should not be used as such.
- This product is not intended for use as a medical monitor.
- Do not use this product near water. For example, do not use it next to a bath tub, wash bowl, kitchen sink, laundry tub or swimming pool, or in a wet basement or shower.
- CAUTION:** Use only the battery provided. There may be a risk of explosion if a wrong type of battery is used for the parent unit. The battery cannot be subjected to high or low extreme temperature and low air pressure at high altitude during use, storage or transportation. Disposal of battery into fire or a hot oven, or mechanically crushing or cutting or the battery can result in an explosion. Leaving the battery in an extremely high temperature surrounding environment can result in an explosion or the leakage of flammable liquid or gas. Battery subjected to extremely low air pressure may result in an explosion or the leakage of flammable liquid or gas. Dispose of used battery according to the instructions.
- Use only the adapters included with this product. Incorrect adapter polarity or voltage can seriously damage the product.
  - Power adapter information:  
Output: 6V DC 400mA  
Ten Pao Industrial Co., Ltd.  
Model: S003ATV0600040(EU), S003ATB0600040(UK);
  - Rechargeable battery information:  
Ni-MH AAA800mAh 3.6V  
Model: Corun - Ni-MH AAA800mAh 3.6V
- The power adapters are intended to be correctly oriented in a vertical or floor mount position. The prongs are not designed to hold the plug in place if it is plugged into a ceiling, under-the-table or cabinet outlet. For pluggable equivalent, the socket-outlet shall be installed near the equipment and shall be easily accessible.
- Unplug this product from the wall outlet before cleaning. Do not use liquid or aerosol cleaners. Use a damp cloth for cleaning.
- Do not cut off the power adapters to replace them with other plugs, as this causes a hazardous situation.
- Do not allow anything to rest on the power cords. Do not install this product where the cords may be walked on or crimped.
- This product should be operated only from the type of power source indicated on the marking label. If you are not sure of the type of power supply in your home, consult your dealer or local power company.
- Do not overload wall outlets or use an extension cord.
- Do not place this product on an unstable table, shelf, stand or other unstable surfaces.
- This product should not be placed in any area where proper ventilation is not provided. Slots and openings in the back or bottom of this product are provided for ventilation. To protect them from overheating, these openings must not be blocked by placing the product on a soft surface such as a bed, sofa or rug. This product should never be placed near or over a radiator or heat register.
- Never push objects of any kind into this product through the slots because they may touch dangerous voltage points or create a short circuit. Never spill liquid of any kind on the product.
- To reduce the risk of electric shock, do not disassemble this product, but take it to an authorized service facility. Opening or removing parts of the product other than specified access doors may expose you to dangerous voltages or other risks. Incorrect reassembling can cause electric shock when the product is subsequently used.
- You should test the sound reception every time you turn on the units or move one of the components.
- Periodically examine all components for damage.
- There is a very low risk of privacy loss when using certain electronic devices, such as baby monitors, cordless telephones, etc. To protect your privacy, make sure the product has never been used before purchase, reset the baby monitor periodically by powering off and then powering on the units, and power off the baby monitor if you will not use it for some time.
- Children should be supervised to ensure that they do not play with this product.
- The product is not intended for use by persons (including children) with reduced physical, sensory or mental capabilities, or lack of experience and knowledge, unless they have been given supervision or instruction concerning use of the appliance by a person responsible for their safety.

#### SAVE THESE INSTRUCTIONS

**Cautions**

- Use and store the product at a temperature between 0°C and 40°C.
- Do not expose the product to extreme cold, heat or direct sunlight. Do not put the product close to a heating source.
- Batteries should not be exposed to excessive heat such as bright sunshine or fire.
- Warning—Strangulation Hazard—** Children have STRANGLED in cords. Keep this cord out of the reach of children (more than 3 ft (0.9 m) away). Do not remove this tag.
- Never place the baby unit(s) inside the baby's cot or playpen. Never cover the baby unit(s) or parent unit with anything such as a towel or a blanket.
- Other electronic products may cause interference with your baby monitor. Try installing your baby monitor as far away from these electronic devices as possible: wireless routers, radios, cellular telephones, intercoms, room monitors, televisions, personal computers, kitchen appliances and cordless telephones.

**Precautions for users of implanted cardiac pacemakers**  
Cardiac pacemakers (applies only to digital cordless devices): Wireless Technology Research, LLC (WTR), an independent research entity, led a multidisciplinary evaluation of the interference between portable wireless devices and implanted cardiac pacemakers. Supported by the U.S. Food and Drug Administration, WTR recommends to physicians that:

- Pacemaker patients**
- Should keep wireless devices at least six inches from the pacemaker.
- Should NOT place wireless devices directly over the pacemaker, such as in a breast pocket, when it is turned ON.

WTR's evaluation did not identify any risk to bystanders with pacemakers from other persons using wireless devices.  
**Electromagnetic fields (EMF)**  
This VTech product complies with all standards regarding electromagnetic fields (EMF), if handled properly and according to the instructions in this user's manual, the product is safe to be used based on scientific evidence available today.

## 1 CONNECT AND CHARGE THE BATTERY

### NOTES

- The rechargeable battery is pre-installed in your parent unit.
- Use only the power adaptors supplied with this product.
- Make sure the baby monitor is not connected to the switch controlled electric outlet.
- Connect the power adaptors in a vertical or floor mount position only. The adaptors' prongs are not designed to hold the weight of baby monitor, so do not connect them to any ceiling, under-the-table, or cabinet outlets. Otherwise, the adaptors may not properly connect to the outlets.
- Make sure the parent unit, the baby unit and the power adaptor cords are out of reach of children.

### Connect the baby monitor

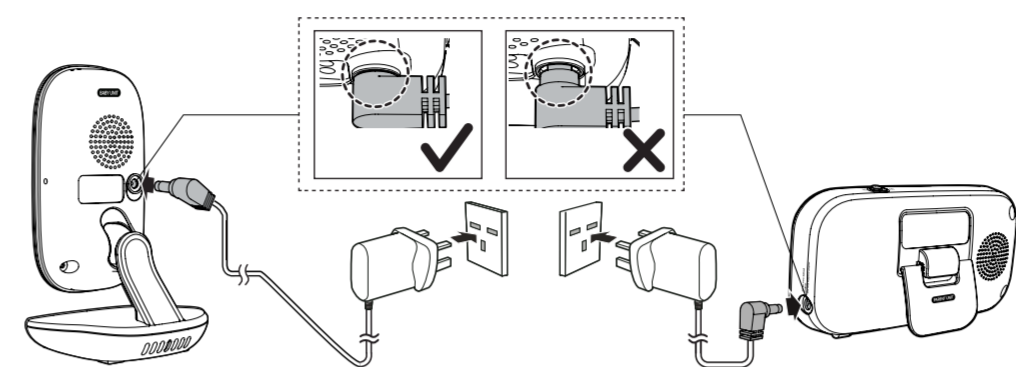

### Charge the parent unit battery

When you have connected and turned on the parent unit, the battery will be charged automatically. The battery icon indicates the battery status (see the following table).

### NOTES

- Before using the baby monitor for the first time, charge the parent unit battery for 12 hours. When the parent unit battery is fully charged, the battery icon becomes solid
- It takes longer to charge the battery when the parent unit is turned on. To shorten the charging time, turn the parent unit off while charging.
- The standby time varies depending on the volume level you set and your actual use.

BATTERY INDICATORS	BATTERY STATUS	ACTION
The screen displays <b>Battery low at Parent Unit</b> . The  or	The battery has very little charge and may be used for only a short time.	Charge without interruption (about 30 minutes).
The battery icon becomes solid	The battery is fully charged.	To keep the battery charged, connect it to AC power when not in use.

## 2 BEFORE USE

### NOTE

- This baby monitor should be used as an aid and proper adult supervision is required.

### Test your baby monitor

You may test the baby monitor before initial use, and at regular times thereafter.

### CAUTION

- For hearing protection, make sure the parent unit is more than 1 metre away from both baby units. If you hear any high-pitched noise, move the parent unit further until the noise stops. You can also press **VOL** on the parent unit to reduce the noise.

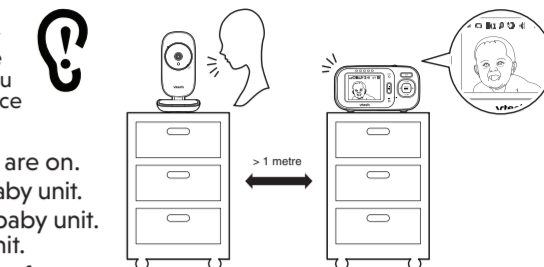

- Make sure your baby unit and parent unit are on.
- The parent unit displays images from the baby unit.
  - Speak towards the microphone of the baby unit. You will hear the sound at the parent unit.
- If you have two baby units, view the image from one of them by switching cameras via menu. Then, repeat step 2.

### NOTE

- When the parent unit displays **No link to Camera**, and the **POWER** LED light flashes, move the parent unit closer to the baby units (observe the minimum distance of 1 metre). You can also check if the baby unit is connected to a live power socket and switched on.

### TIP

- Increase the speaker volume of the parent unit if you cannot hear the sounds transmitted from the baby units.

### Positioning the baby monitor

#### CAUTION

- Keep the baby unit out of the reach of your baby. Never place or mount the baby unit inside the baby's cot or playpen.

#### NOTE

- To avoid interference from other electronic devices, place your baby monitor far away from devices such as wireless routers, microwaves, cell phones and computers.

- Place the baby units more than 1 metre away from your baby.
- Adjust the angle of the baby unit camera to aim at your baby.
- Place the parent unit more than 1 metre away from the baby units.

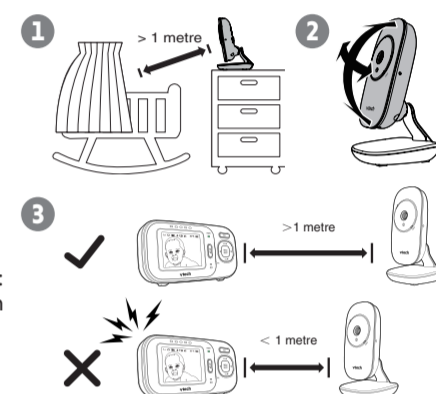

#### CAUTION

- The default volume of your parent unit is level 3, and the maximum volume is level 5. If you experience high-pitched screaming noise from your baby monitor while positioning:
  - Make sure your baby units and parent unit are more than 1 metre apart, OR
  - Turn down the volume of your parent unit.

### Operating range

The operating range of the baby monitor is up to 1000 feet (300 metres) outdoors or 160 feet (50 metres) indoors. The actual operating range may vary depending on the environmental conditions and other interferences such as walls, doors and other obstructions.

## 3 USING THE BABY MONITOR

### Power on or off the baby unit

- Slide the **ON/OFF** switch to **ON** to turn on the baby unit. The **POWER** LED light turns on.
- Slide the **ON/OFF** switch to **OFF** to turn off the baby unit. The **POWER** LED light turns off.

### Power on or off the parent unit

- Slide the **ON/OFF** switch to **ON** to turn on the parent unit. The screen and the **POWER** LED light turns on.
- Slide the **ON/OFF** switch to **OFF** to turn off the parent unit. The screen and the **POWER** LED light turns off.

### Adjust parent unit speaker volume

- Press **VOL** on the parent unit to adjust the speaker volume.

### Adjust LCD brightness

You can change the brightness of the parent unit screen from **Level 1** to **Level 5**. The LCD brightness is preset to **Level 3**.

- Press **MENU** when the parent unit is idle.
- Press **◀** or **▶** to choose
- Press **▼** or **▲** to choose the desired level of brightness, then press **MENU** to confirm your selection.

### Turn off parent unit screen

- Press **OFF** to turn off the screen. You can still hear sound from the baby unit.
- Press again to turn on the screen.

### Screen off timer

You can set the screen off time for the parent unit when there is no key press for a specific time interval.

When the screen is turned off, you can still hear sound from the baby unit.

- Press **MENU** when the parent unit is idle.
- Press **◀** or **▶** to choose
- Press **▼** or **▲** to choose the desired time period to automatically turn off screen (**OFF** / - 5 min. / - 30 min. / - 60 min.), then press **MENU** to confirm your selection.

### Lullaby

The baby monitor has two lullabies and two soothing sounds for you to comfort your baby. You can play the lullabies or soothing sounds on the baby unit using the parent unit.

- Press **MENU** when the parent unit is idle.
- Press **◀** or **▶** to choose
- Press **▲** to choose
- Press **▼** or **▲** to choose a lullaby or a soothing sound, or choose **STOP** to stop playing.
- Press **MENU** to confirm your selection.

#### NOTE

- The selected lullaby plays for 30 minutes and stops automatically.
- The lullaby playback on the baby unit will be paused when receiving talkback from the parent unit.

### Adjust the sound sensitivity of the baby unit

You can choose to hear sounds from the baby unit all the time, or to hear sounds that exceed a certain level. You can use the parent unit to adjust the microphone sensitivity of your baby unit. The higher the sensitivity level, the more sensitive the baby unit is in detecting sounds for transmitting to the parent unit. The VOX sensitivity level is preset to the highest level (**Level 5**).

VOX SENSITIVITY LEVEL	Level 5	Level 4	Level 3	Level 2	Level 1
SENSITIVITY	Highest VOX sensitivity level	High VOX sensitivity level	Medium VOX sensitivity level	Low VOX sensitivity level	Lowest VOX sensitivity level
DESCRIPTION	The parent unit speaker is constantly on, and you will hear all sounds (including background noises) from your baby's room.	The parent unit speaker turns on for soft babbling and louder sounds from your baby. It remains quiet when your baby sleeps soundly.	The parent unit speaker turns on for loud babbling and louder sounds from your baby. It remains quiet when your baby makes soft sounds.	The parent unit speaker turns on for crying and louder sounds from your baby. It remains quiet when your baby makes soft sounds.	The parent unit speaker turns on for loud crying or screaming sounds from your baby. It remains quiet when your baby makes soft sounds.

- Press **MENU** when the parent unit is idle.
- Press **◀** or **▶** to choose
- Press **▼** or **▲** to choose the desired sensitivity level, then press **MENU** to confirm your selection.

#### NOTE

- If the screen is off, and the setting of sound-activated screen is **ON**, then LCD screen will be turned on automatically when VOX sensitivity is triggered.

#### TIP

- If you want to use a sound machine or white noise machine for natural white noise while using this baby monitor to check on your baby, you can:
  - Lower the volume of your sound machine or white noise machine; or
  - Lower the sensitivity level of your baby monitor to medium (level 3) or below. Default level is the highest level.

### Turn on or off the sound activation

When sound activation is on, as long as no sound is detected within 50 seconds, the parent unit screen will turn off automatically to save power.

When your baby unit detects a sound, which exceeds the selected sensitivity level, the sound activation triggers the parent unit screen to turn on automatically. When no sound is detected within 50 seconds, the screen will be off again.

- Press **MENU** when the parent unit is idle.
- Press **◀** or **▶** to choose
- Press **▼** or **▲** to choose **ON** or **OFF**, then press **MENU** to confirm your selection.

#### NOTE

- If the sound sensitivity is set to the highest level, the parent unit screen may remain on continuously even though sound activation is on. This depends on whether the baby unit detects any sounds.

## TECHNICAL SPECIFICATIONS

Frequency control	Crystal controlled PLL synthesizer
Transmit frequency	Baby unit: 2405 - 2475 MHz Parent unit: 2405 - 2475 MHz
Channels	32
LCD	2.4" Color LCD (QVGA 320x240 pixels)
Nominal effective range	Actual operating range may vary according to environmental conditions at the time of use.
Power requirements	Parent unit: 3.6V Ni-MH battery Baby unit power adaptor: Output: 6V DC @ 400mA Parent unit power adaptor: Output: 6V DC @ 400mA



## 6 BABY UNIT OVERVIEW

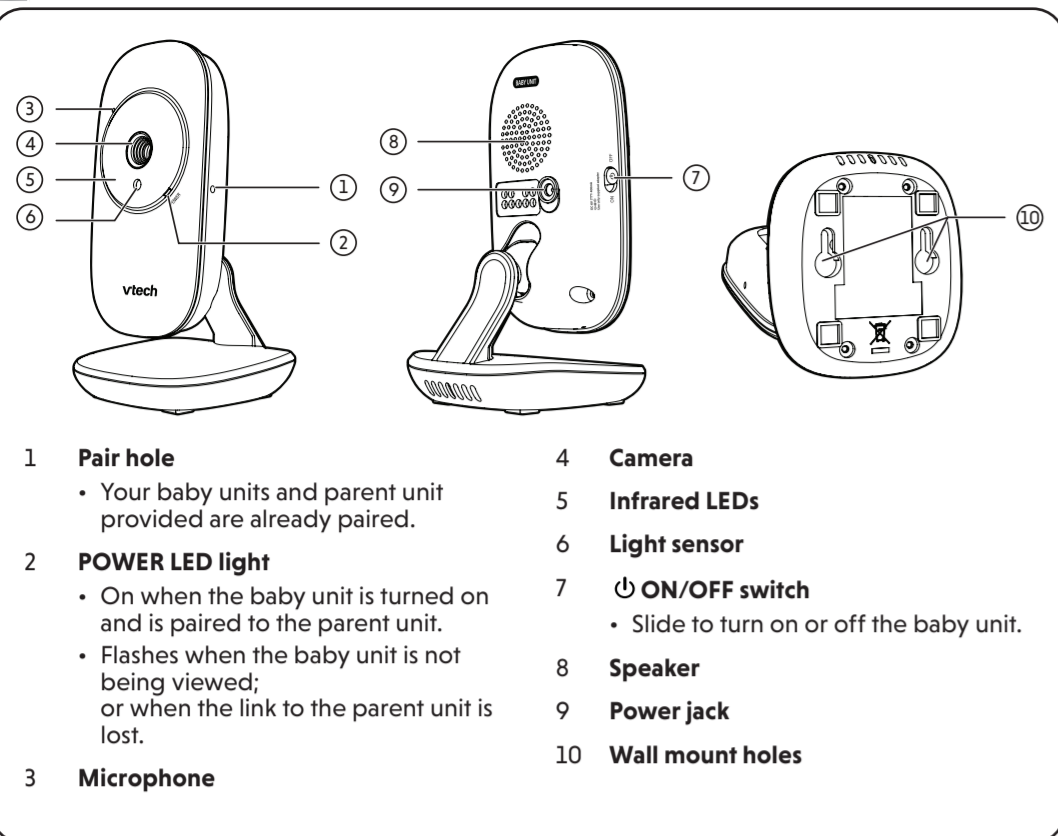

- Pair hole**
  - Your baby units and parent unit provided are already paired.
- POWER LED light**
  - On when the baby unit is turned on and is paired to the parent unit.
  - Flashes when the baby unit is not being viewed; or when the link to the parent unit is lost.
- Microphone**
- Camera**
- Infrared LEDs**
- Light sensor**
- ON/OFF switch**
  - Slide to turn on or off the baby unit.
- Speaker**
- Power jack**
- Wall mount holes**

## 7 PARENT UNIT OVERVIEW

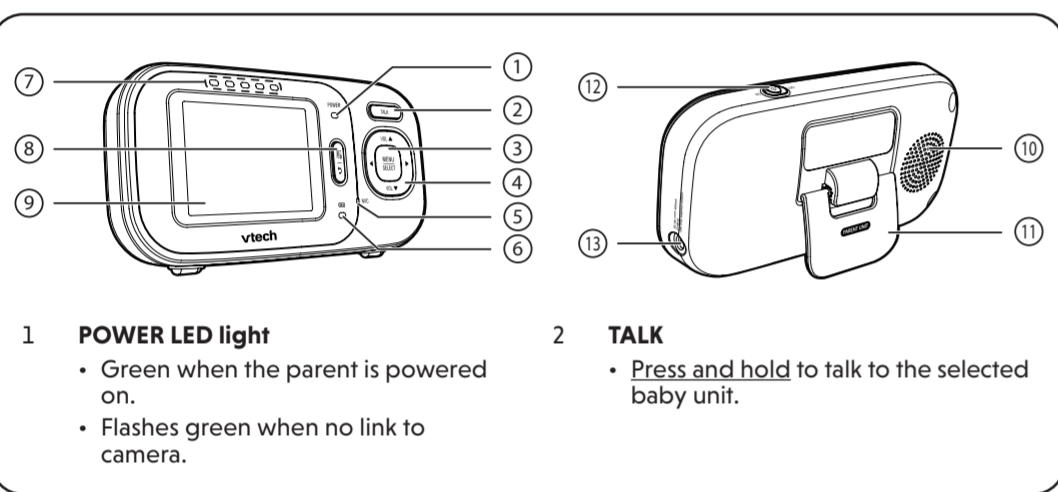

- POWER LED light**
  - Green when the parent is powered on.
  - Flashes green when no link to camera.
- TALK**
  - Press and hold to talk to the selected baby unit.

## 8 PARENT UNIT OVERVIEW (CONT'D)

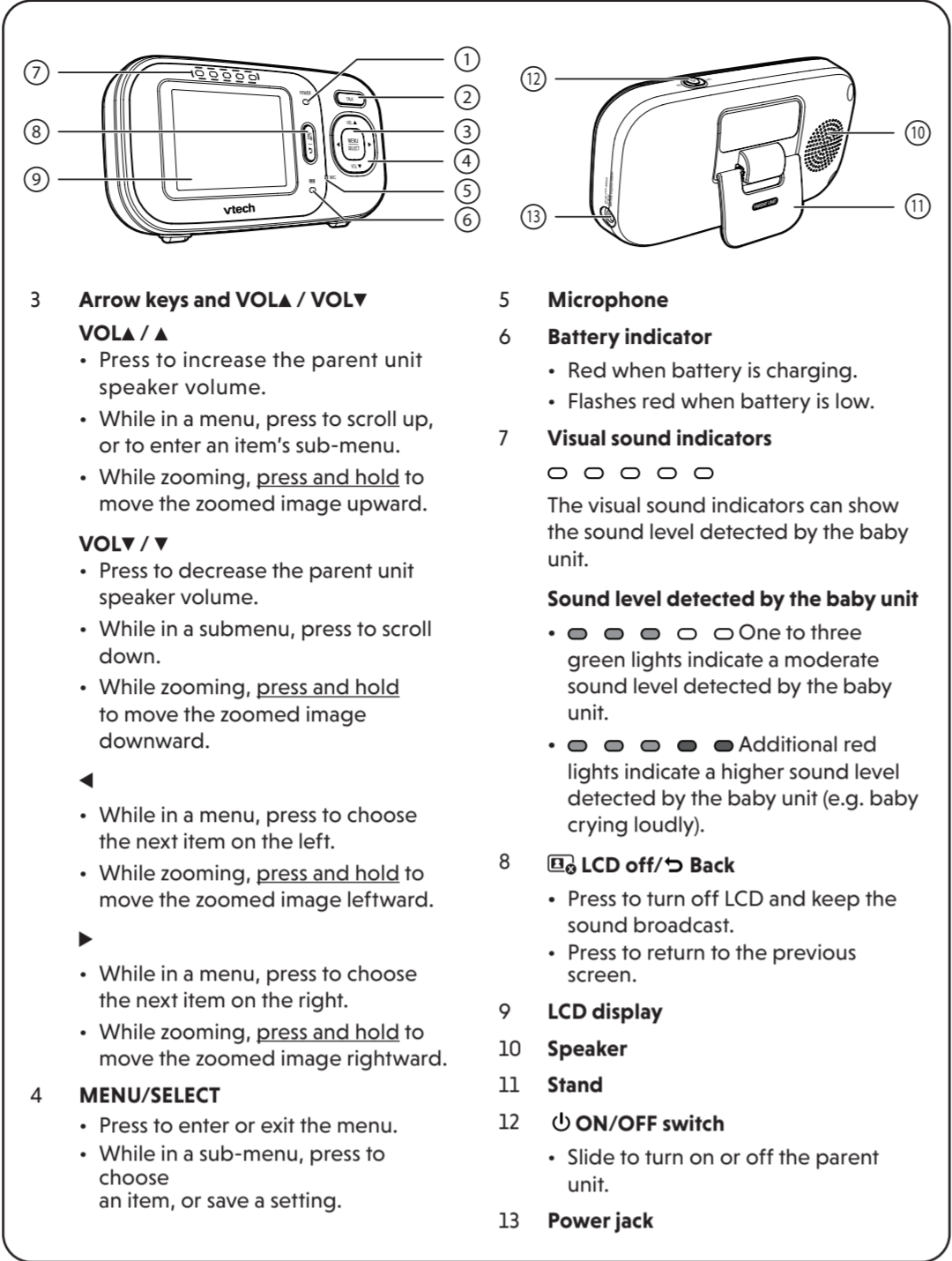

- Arrow keys and VOL▲ / VOL▼**
  - VOL▲ / ▲**
    - Press to increase the parent unit speaker volume.
    - While in a menu, press to scroll up, or to enter an item's sub-menu.
    - While zooming, **press and hold** to move the zoomed image upward.
  - VOL▼ / ▼**
    - Press to decrease the parent unit speaker volume.
    - While in a submenu, press to scroll down.
    - While zooming, **press and hold** to move the zoomed image downward.
- MENU/SELECT**
  - Press to enter or exit the menu.
  - While in a sub-menu, press to choose an item, or save a setting.
- Microphone**
- Battery indicator**
  - Red when battery is charging.
  - Flashes red when battery is low.
- Visual sound indicators**
  - The visual sound indicators can show the sound level detected by the baby unit.
  - Sound level detected by the baby unit**
    - One to three green lights indicate a moderate sound level detected by the baby unit.
    - Additional red lights indicate a higher sound level detected by the baby unit (e.g. baby crying loudly).
- LCD off/Back**
  - Press to turn off LCD and keep the sound broadcast.
  - Press to return to the previous screen.
- LCD display**
- Speaker**
- Stand**
- ON/OFF switch**
  - Slide to turn on or off the parent unit.
- Power jack**

## 9 PARENT UNIT ICONS

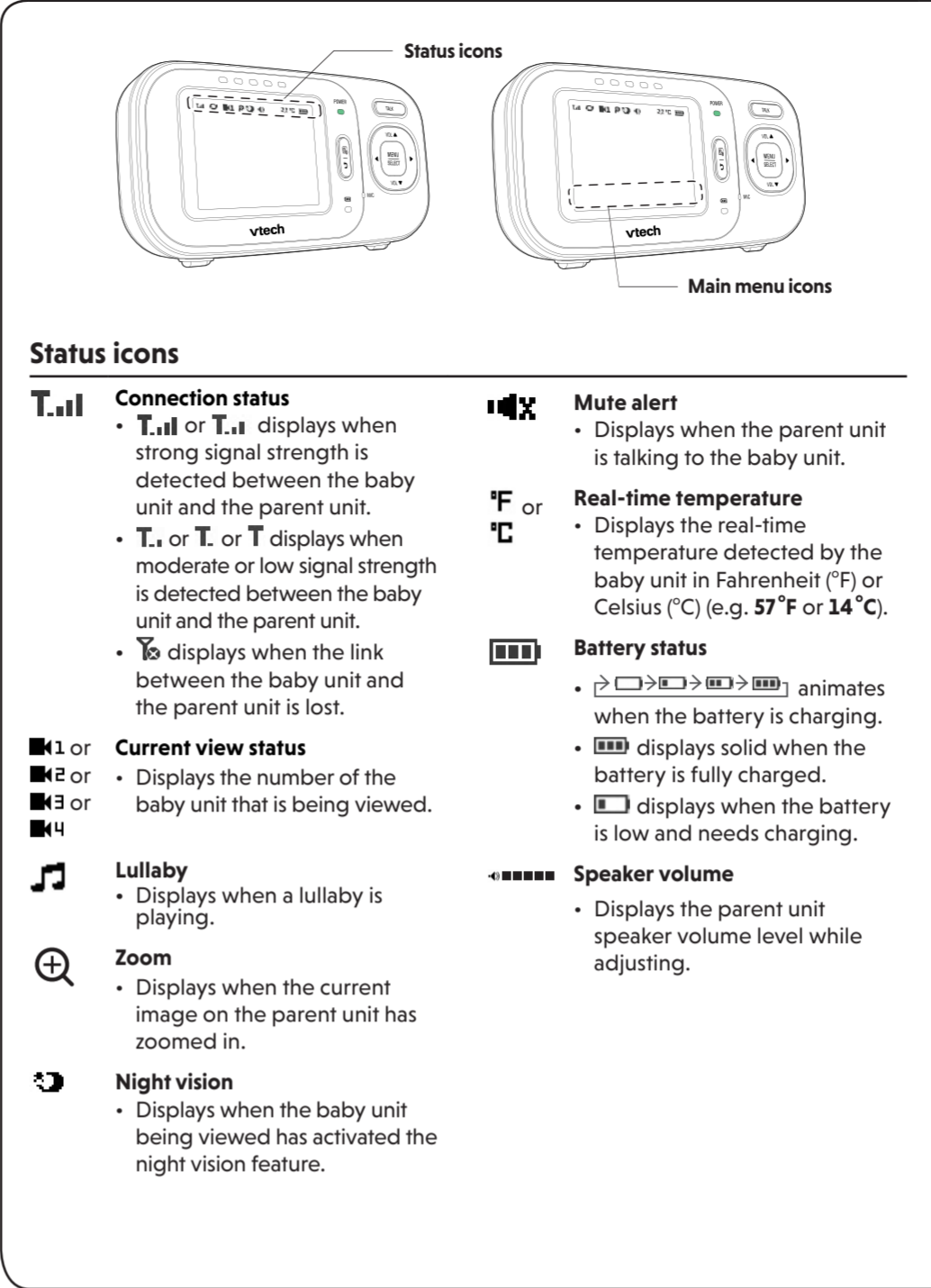

- ### Status icons
- Connection status**
    - T** or **T** displays when strong signal strength is detected between the baby unit and the parent unit.
    - T** or **T** displays when moderate or low signal strength is detected between the baby unit and the parent unit.
    - T** displays when the link between the baby unit and the parent unit is lost.
  - Mute alert**
    - Displays when the parent unit is talking to the baby unit.
  - Real-time temperature**
    - Displays the real-time temperature detected by the baby unit in Fahrenheit (°F) or Celsius (°C) (e.g. **57°F** or **14°C**).
  - Battery status**
    - animates when the battery is charging.
    - displays solid when the battery is fully charged.
    - displays when the battery is low and needs charging.
  - Current view status**
    - Displays the number of the baby unit that is being viewed.
  - Lullaby**
    - Displays when a lullaby is playing.
  - Zoom**
    - Displays when the current image on the parent unit has zoomed in.
  - Night vision**
    - Displays when the baby unit being viewed has activated the night vision feature.
- ### Main menu icons
- Mute alert**
    - Displays when the parent unit is talking to the baby unit.
  - Real-time temperature**
    - Displays the real-time temperature detected by the baby unit in Fahrenheit (°F) or Celsius (°C) (e.g. **57°F** or **14°C**).
  - Battery status**
    - animates when the battery is charging.
    - displays solid when the battery is fully charged.
    - displays when the battery is low and needs charging.
  - Speaker volume**
    - Displays the parent unit speaker volume level while adjusting.

### Main menu icons

- Zoom**
  - You can zoom in or out with 1x, 2x options while viewing image.
- Lullaby**
  - You can select, play, or stop a lullaby.
- Brightness**
  - You can change the brightness of the parent unit screen.
- LCD screen off timer**
  - You can set a specific time to turn the screen off.
- VOX sensitivity**
  - With this feature, you can choose to hear sounds from the baby unit all the time, or to hear sounds that exceed a certain level. You can use the parent unit to adjust the microphone sensitivity of your baby unit. The higher the sensitivity level, the more sensitive the baby unit is in detecting sounds for transmitting to the parent unit.
- Sound-activated screen**
  - When the baby unit detects no sound, the parent unit screen stays off to save power. Once a sound is detected, the parent unit screen turns on automatically. It will then turn off again after 50 seconds of no sound detection.
- Temperature**
  - You can turn on the temperature alert tone so that the parent unit beeps whenever the room temperature detected by the baby unit falls outside of the desired temperature range. You can choose in Fahrenheit (°F) or Celsius (°C) as the temperature format displayed, or set the maximum/minimum temperature limit for alerts.

### Warning icons and messages

- The selected baby unit is out of range or is turned off.
- The battery is empty and needs to be recharged.
- The temperature detected by the baby unit is higher/lower than the desired temperature alert range.
- The parent unit is searching for baby units.
- The parent unit is connected to AC power.

## 10 DIM MODE

The dim mode is to help you save the parent unit power. Your parent unit display will dim automatically after 10 minutes of inactivity, in which there is neither key pressed nor alert received from the baby unit.

- NOTES**
- While the screen is dimmed, any keypress or alert message will trigger the screen to return to the preset brightness level. After 10 minutes of inactivity, it will dim again.

## 11 NIGHT VISION

The baby unit has infrared LEDs that allow you to see your baby clearly at night or in a dark room. When the baby unit being viewed detects low light levels, the infrared LEDs are switched on automatically. The images from the baby unit are in black and white, and appears on the screen.

- NOTES**
- It is normal if you see a short white glare on your parent unit screen as the baby unit is adapting to the dark environment.
  - When the infrared LEDs are on, the images are in black and white. This is normal.

**TIP**

- Depending on the surroundings and other interfering factors, like lightings, objects, colors and backgrounds, the display resolution may vary. Adjust the baby unit's angle or place the baby unit at a higher level to prevent glare and blurry display.

## 12 MOUNT THE BABY UNIT (OPTIONAL)

Your baby monitor comes ready for tabletop use. You can also choose to mount your baby monitor on the wall.

## 13 GENERAL PRODUCT CARE

- To keep this product working well and looking good, follow these guidelines:
- Avoid putting it near heating appliances and devices that generate electrical noise (for example, motors or fluorescent lamps).
  - DO NOT expose it to direct sunlight or moisture.
  - Avoid dropping the product or treating it roughly.
  - Clean with a soft cloth.
  - DO NOT immerse the parent unit and the baby unit in water and do not clean them under the tap.
  - DO NOT use cleaning spray or liquid cleaners.
  - Make sure the baby unit and parent unit are dry before you connect them to the mains again.

## 14 STORAGE

When you are not going to use the baby monitor for some time, store the parent unit, the baby unit and the adaptors in a cool and dry place.

## 15 FREQUENTLY ASKED QUESTIONS

Below are the questions most frequently asked about the baby monitor.

Why does the baby monitor not respond normally?	Try the following (in the order listed) for common cure: 1. Disconnect the power to the baby units and the parent unit. 2. Wait a few seconds before connecting power back to the baby units and the parent unit. 3. Turn on the baby units and the parent unit. 4. Wait for the parent unit to synchronize with the baby units. Allow up to one minute for this to take place.
Why don't the power-on light of the baby unit and parent unit go on when I switch on the units?	Perhaps the parent unit is not connected to the power. Insert the appliance plug into the parent unit and put the adaptor in a wall socket. Then, slide the <b>ON/OFF</b> switch on the parent unit and to establish connection with the baby unit. Perhaps the baby unit is not connected to the power. Insert the appliance plug into the baby unit and put the adaptor in a wall socket. Then, slide the <b>ON/OFF</b> switch to <b>ON</b> to switch on the baby unit and to establish connection with the parent unit.
Why doesn't my parent unit charge while connected to AC power?	Make sure the power is not controlled by a wall switch.
Why is my screen in black and white?	The screen is in black and white during night-time or in a dark room when the night vision feature is activated. This is normal.
Why do I get glare or blurry display on my screen when viewing my baby at night?	During night-time or in a dark room, the surroundings and other interfering factors, like lightings, objects, colors and backgrounds may affect the image quality on your parent unit screen. Adjust the baby unit's angle or place the baby unit at a higher level to prevent glare and blurry display.
Why does the baby monitor produce a high-pitched noise?	The parent unit and baby units may be too close to each other. • Move the parent unit away from the baby units until the noise stops; OR • Turn down the volume of your parent unit.
Why does the parent unit beep?	The baby units may be out of range. Move the parent unit closer to the baby units (but not less than 1 metre). The parent unit may not have enough charge for the parent unit to perform normally. Charge the battery in the parent unit until the battery icon becomes solid . The temperature of your baby's room may be too high or too low.
Why don't I hear a sound/Why can't I hear my baby cry?	The parent unit speaker volume may be too low. Press <b>VOL▲</b> to increase the volume, or use the parent unit menu to change sound sensitivity level to the highest level ( <b>level 5</b> ).
Why can't I establish a connection? Why is the connection lost every now and then? Why are there sound interruptions?	The baby units may be out of range. Move the parent unit closer to the baby units (but not less than 1 metre). Other electronic products may cause interference with your baby monitor. Try installing your baby monitor as far away from these electronic devices as possible. If you power on only one baby unit, your parent unit may display  and the <b>POWER LED</b> light flashes. Press <b>VIEW</b> to switch to the baby unit you have powered on.

## 16 CUSTOMER SERVICE AND PRODUCT WARRANTY

### PRODUCT WARRANTY

Thank you for choosing this quality product from VTech. We hope it will bring many hours of entertainment, imaginative play and learning.

1. The product detailed above is covered by a one year warranty from the date of purchase, against any defects in materials or workmanship.

2. The product may be returned to the place of purchase. Alternatively the product can be returned to VTech Electronics Europe plc (see address below), with proof of purchase, without proof of purchase no replacement will be provided.

3. VTech Electronics Europe plc will examine the product and if it is found to be defective due to faulty materials or workmanship, will replace the product at their discretion.

4. If the product covered by this warranty is damaged due to misuse, modification or unauthorised repair, or because of faulty batteries, battery discharge or incorrect electrical connections, then this warranty becomes void.

5. This warranty is personal to the original purchaser and is not transferable.

6. Breakages to the LCD screen are not covered by the warranty.

7. Returns to VTech Electronics Europe plc should include a cheque or postal order for £1.50 towards the cost of return postage and packaging.

8. Products returned to VTech Electronics Europe plc, should be addressed as follows and packed carefully to avoid damage in transit (Please do not include batteries or adaptor). Please include details of the fault together with your name and address.

9. To keep an online record of your warranty, please register your product online at [www.vtech.co.uk/warranty](http://www.vtech.co.uk/warranty)

VTech Electronics EU PLC, c/o XPO Logistics, Warehouse 350, Cat & Fiddle Lane, West Hallam, DE7 6HE

THIS WARRANTY IS OFFERED AS AN EXTRA BENEFIT AND DOES NOT AFFECT CONSUMERS' STATUTORY RIGHTS.

This warranty is valid for the UK and Eire only. For products purchased outside the UK and Eire, please contact your local distributor or place of purchase.

**IMPORTANT**

Please retain this booklet with your sales receipt as proof of the date of purchase.

**Customer Service**

Please call our Consumer Services Department on 03306 780149 (from UK) or +44 3306 780149 (outside UK) and a service representative will be happy to help you.

## 17 ADULT SUPERVISION

- This baby monitor should be used as an aid and proper adult supervision is required.
- Do not place the baby unit inside the cot or playpen.
- As for children's safety, touch or play with the baby monitor and all the accessories are not allowed. THIS IS NOT A TOY.

## 18 DISPOSAL OF BATTERIES AND PRODUCT

## 19 DECLARATION OF CONFORMITY

This product is intended for use within Europe and UK.

This equipment complies with the essential requirements to EU's Radio Equipment Directive (2014/53/EU) and the UK's Radio Regulations 2017 on radio systems and telecommunication equipment.

VTech Telecommunications Ltd. hereby declares that this Video Monitor VM2251 is in compliance with the essential requirements and other relevant provisions of EU's Radio Equipment Directive (2014/53/EU) and UK's Radio Equipment Regulations 2017.

The Declaration of Conformity for the VM2251 is available from [www.vtechbabycare.com](http://www.vtechbabycare.com).

Manufacturer: VTech Telecommunications Ltd.  
23/F., Tai Ping Industrial Centre, Block 1, 57 Ting kok Road, Tai Po, Hong Kong.

Importer: VTech Electronics Europe plc  
Napier Court, Abingdon Science Park, Abingdon, Oxon, OX14 3YT, U.K.