



OWNER'S MANUAL

WASHING MACHINE



Before beginning installation, read these instructions carefully. This will simplify installation and ensure that the product is installed correctly and safely. Leave these instructions near the product after installation for future reference.

EN ENGLISH

F*V509*



MFL71445713
Rev.01_053119

www.lg.com

Copyright © 2019 LG Electronics Inc. All Rights Reserved

TABLE OF CONTENTS

This manual may contain images or content different from the model you purchased. This manual is subject to revision by the manufacturer.

| | |
|--|-----------|
| IMPORTANT SAFETY INSTRUCTIONS | 3 |
| READ ALL INSTRUCTIONS BEFORE USE | 3 |
| WARNING | 3 |
| CARING FOR THE ENVIRONMENT | 8 |
| Disposal of Your Old Appliance | 8 |
| INSTALLATION | 9 |
| Parts and Specifications | 9 |
| Installation Place Requirements | 10 |
| Unpacking the Appliance | 12 |
| Levelling the Appliance | 12 |
| Connecting the Water Inlet Hose | 13 |
| Installing the Drain Hose | 14 |
| OPERATION | 15 |
| Operation Overview | 15 |
| Preparing the Laundry | 15 |
| Adding Detergents and Softeners | 16 |
| Control Panel | 18 |
| Programme Table | 19 |
| Consumption Data | 22 |
| Extra Options and Functions | 23 |
| SMART FUNCTIONS | 25 |
| Using LG SmartThinQ Application | 25 |
| Using Smart Diagnosis | 28 |
| MAINTENANCE | 29 |
| Cleaning After Every Wash | 29 |
| Cleaning the Appliance Periodically | 30 |
| TROUBLESHOOTING | 32 |
| Before Calling for Service | 32 |
| OPERATING DATA | 39 |
| Product Fiche | 39 |

READ ALL INSTRUCTIONS BEFORE USE

The following safety guidelines are intended to prevent unforeseen risks or damage from unsafe or incorrect operation of the appliance.

The guidelines are separated into 'WARNING' and 'CAUTION' as described below.

Safety Messages

 This symbol is displayed to indicate matters and operations that can cause risk. Read the part with this symbol carefully and follow the instructions in order to avoid risk.

 **WARNING**

This indicates that the failure to follow the instructions can cause serious injury or death.

 **CAUTION**

This indicates that the failure to follow the instructions can cause the minor injury or damage to the product.

WARNING

 **WARNING**

To reduce the risk of explosion, fire, death, electric shock, injury or scalding to persons when using this product, follow basic precautions, including the following:

Technical Safety

- This appliance can be used by children aged from 8 years and above and persons with reduced physical, sensory or mental capabilities or lack of experience and knowledge if they have been given supervision or instruction concerning use of the appliance in a safe way and understand the hazards involved. Children shall not play with the appliance. Cleaning and user maintenance shall not be made by children without supervision.
- Children of less than 3 years should be kept away unless continuously supervised.
- If the power cord is damaged, it must be replaced by the manufacturer, its service agent or similarly qualified persons in order to avoid a hazard.
- Ventilation openings must not be obstructed by a carpet.
- This appliance is intended to be used in household only and not in applications such as;
 - Staff kitchen areas in shops, offices and other working environments;
 - Farm houses;
 - By clients in hotels, motels and other residential type environments;
 - Bed and breakfast type environments;
 - Areas for communal use in blocks of flats or in launderettes
- Use a new hose or hose-set supplied with the appliance. Reusing old hoses can cause a water leak and subsequent property damage.
- The water pressure must be between 100 and 1000 kPa.
- The maximum capacity in some cycles for dry clothes to be washed is 9 kg.

Installation

- Never attempt to operate the appliance if it is damaged, malfunctioning, partially disassembled, or has missing or broken parts, including a damaged cord or plug.
- This appliance should only be transported by two or more people holding the appliance securely.

- Do not install the appliance in a damp and dusty place. Do not install or store the appliance in any outdoor area, or any area that is subject to weathering conditions such as direct sunlight, wind, or rain or temperatures below freezing.
- Tighten the drain hose to avoid separation.
- If the power cord is damaged or the hole of the socket outlet is loose, do not use the power cord and contact an authorized service centre.
- Do not plug the appliance into multiple outlet sockets, power boards, or an extension power cable.
- This appliance must not be installed behind a lockable door, a sliding door or a door with a hinge on the opposite side to that of the appliance, in such a way that a full opening of the appliance door is restricted.
- This appliance must be grounded. In the event of malfunction or breakdown, grounding will reduce the risk of electric shock by providing a path of least resistance for electric current.
- This appliance is equipped with a power cord having an equipment grounding conductor and a grounding power plug. The power plug must be plugged into an appropriate socket outlet that is installed and grounded in accordance with all local codes and ordinances.
- Improper connection of the equipment-grounding conductor can result in risk of electric shock. Check with a qualified electrician or service personnel if you are in doubt as to whether the appliance is properly grounded.
- Do not modify the power plug provided with the appliance. If it does not fit the outlet, have a proper outlet installed by a qualified electrician.

Operation

- Do not attempt to separate any panels or disassemble the appliance.
- Do not apply any sharp objects to the control panel in order to operate the appliance.

- Do not repair or replace any part of the appliance. All repairs and servicing must be performed by qualified service personnel unless specifically recommended in this Owner's Manual. Use only authorized factory parts.
- Do not put animals, such as pets into the appliance.
- Keep the area underneath and around the appliance free of combustible materials such as lint, paper, rags, chemicals, etc.
- Do not leave the appliance door open. Children may hang on the door or crawl inside the appliance, causing damage or injury.
- Use new hose or hose-set supplied with the appliance. Reusing old hoses can cause a water leak and subsequent property damage.
- Do not put in, wash or dry articles that have been cleaned in, washed in, soaked in, or spotted with combustible or explosive substances (such as waxes, wax removers, oil, paint, gasoline, degreasers, drycleaning solvents, kerosene, petrol, spot removers, turpentine, vegetable oil, cooking oil, acetone, alcohol, etc.). Improper use can cause fire or explosion.
- Never reach into the appliance while it is operating. Wait until the drum has completely stopped.
- In case of flood, disconnect the power plug and contact the LG Electronics customer information centre.
- Do not push down the door excessively, when the appliance door is open.
- Do not touch the door during a high temperature programme.
- Do not use flammable gas and combustible substances (benzene, gasoline, thinner, petroleum, alcohol, etc.) near the appliance.
- If the drain hose or inlet hose is frozen during winter, use it only after thawing.
- Keep all washing detergents, softener and bleach away from children.
- Do not touch the power plug or the appliance controls with wet hands.
- Do not bend the power cable excessively or place a heavy object on it.
- Do not wash rugs, mats, shoes or pet blankets, or any other items other than clothes or sheets, in this machine.

- This appliance must only be used for domestic household purposes and should not be used in mobile applications.
- If there is a gas leakage (isobutane, propane, natural gas, etc.), do not touch the appliance or power plug and ventilate the area immediately.

Maintenance

- Securely plug the power plug in the socket outlet after completely removing any moisture and dust.
- Disconnect the appliance from the power supply before cleaning the appliance. Setting the controls to the OFF or stand by position does not disconnect this appliance from the power supply.
- Do not spray water inside or outside the appliance to clean it.
- Never unplug the appliance by pulling on the power cable. Always grip the power plug firmly and pull straight out from the socket outlet.

Disposal

- Before discarding an old appliance, unplug it. Cut off the cable directly behind the appliance to prevent misuse.
- Dispose of all packaging materials (such as plastic bags and styrofoam) away from children. The packaging materials can cause suffocation.
- Remove the door before disposing of or discarding this appliance to avoid the danger of children or small animals getting trapped inside.

CARING FOR THE ENVIRONMENT

Disposal of Your Old Appliance



- This crossed-out wheeled bin symbol indicates that waste electrical and electronic products (WEEE) should be disposed of separately from the municipal waste stream.
- Old electrical products can contain hazardous substances so correct disposal of your old appliance will help prevent potential negative consequences for the environment and human health. Your old appliance may contain reusable parts that could be used to repair other products, and other valuable materials that can be recycled to conserve limited resources.
- You can take your appliance either to the shop where you purchased the product, or contact your local government waste office for details of your nearest authorised WEEE collection point. For the most up to date information for your country, please see www.lg.com/global/recycling.

Parts and Specifications

NOTE

- Appearance and specifications may change without notice to improve the quality of the appliance.

Front View

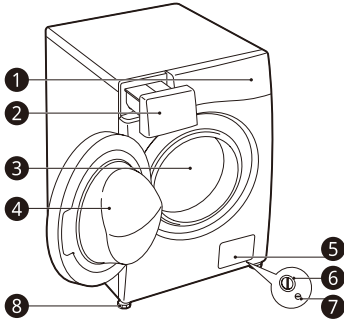

- ❶ Control panel
- ❷ Detergent dispenser drawer
- ❸ Drum
- ❹ Door
- ❺ Cover cap
- ❻ Drain pump filter
- ❼ Drain plug
- ❽ Adjustable feet

Rear View

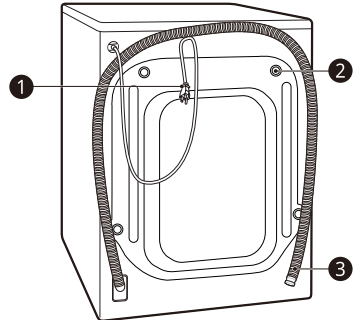

- ❶ Power plug
- ❷ Transit bolts
- ❸ Drain hose

Accessories

* This feature is only available on some models.



- ❶ Cold water inlet hose*
- ❷ Spanner
- ❸ Caps for covering transit bolt holes*
- ❹ Elbow bracket for securing drain hose*

Specifications

| Model | F*V509* |
|---------------------------------------|--------------------------|
| Power Supply | 220 - 240 V~, 50 Hz |
| Dimension (Width x Depth x Height) | 600 mm X 560 mm X 850 mm |
| Product Weight | 63 kg |

- No further backflow protection required for connection to the water inlet.

Installation Place Requirements

Before installing the appliance, check the following information to make sure that the appliance should be installed in a correct place.

Installation Location

- Install the appliance on a flat floor. (Allowable slope under the appliance: 1°)
- Never try to level any uneven floor by putting pieces of wood, cardboard or similar materials under the appliance.
- If it is impossible to avoid positioning the appliance next to a gas cooker or coal burning stove, an insulation (850 X 600 mm) covered with aluminium foil on the side facing the cooker or stove must be inserted between the two appliances.
- Ensure that when the appliance is installed, it is easily accessible for an engineer in the event of a breakdown.
- When installing the appliance, adjust all four feet using the transit bolt spanner which makes the appliance stable, and leave approximate **5 mm** for a clearance between the top of the appliance and the underside of any worktop.
- Additional clearance should have **100 mm** for the wall and **20 mm** for rear, right and left side.

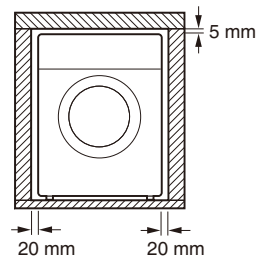
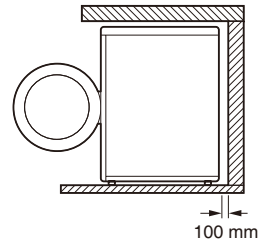

WARNING

- This appliance must only be used for domestic household purposes and should not be used in mobile applications.

NOTE

- If the appliance is installed on a raised platform, it must be securely fastened in order to eliminate the risk of falling off.

Wooden Floors (Suspended Floors)

When installing the appliance on wooden floors, use rubber cups to prevent the appliance from excessive vibration and unbalance.

- To prevent vibration, we recommend you to place rubber cups ❶ at least 15 mm thick of the each foot of the appliance, secured to at least two floor beams with screws.

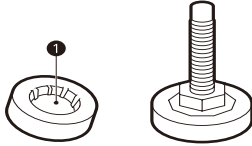

- If possible, install the appliance in one of the corners of the room, where the floor is more stable.
- Fit the rubber cups to reduce vibration.

⚠ CAUTION

- This appliance must only be used for domestic household purposes and should not be used in mobile applications.
- If the appliance is installed on the unstable floor (e.g. wooden floor), the warranty does not cover any damages and cost occurred due to the installation on the unstable floor.

NOTE

- You can purchase rubber cups (Part No. **4620ER4002B**) from the LG Electronics service centre.

Ventilation

- Make sure that air circulation around the appliance should not be impeded by carpets, rugs, etc.

Ambient Temperature

- Do not install the appliance in rooms where freezing temperatures may occur. Frozen hoses may burst under pressure. The reliability of the electronic control unit may be impaired at temperatures below freezing point.
- If the appliance is delivered in winter and temperatures are below freezing, place the appliance at room temperature for a few hours before putting it into operation.

Electrical Connection

- Do not use an extension cord or double adapter.
- Always unplug the appliance and turn off the water inlet after use.
- Connect the appliance to an earthed socket in accordance with current wiring regulations.
- The appliance must be positioned so that the plug is easily accessible.
- Power outlet must be at least 1 meter of either side of the appliance.

⚠ WARNING

- Repairs to the appliance must only be carried out by the qualified personnel. Repairs carried out by inexperienced persons may cause injury or serious malfunctioning. Contact your LG Electronics service centre.
- The power plug must be plugged into an appropriate socket outlet that is installed and grounded in accordance with all local codes and ordinances.

Unpacking the Appliance

Lifting the Appliance Off the Foam Base

* This feature is only available on some models.

After removing the carton and shipping material, lift the appliance off the foam base.

- Make sure the tub support **1*** comes off with the base and is not stuck to the bottom of the appliance.
- If you must lay the appliance down to remove the carton base **2**, always protect the side of the appliance and lay it carefully on its side. Do not lay the appliance on its front or back.

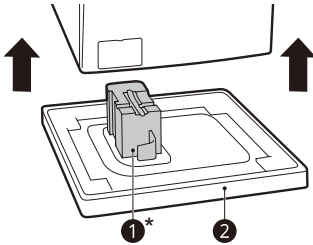

Removing the Bolt Assemblies

- 1 Starting with the bottom transit bolts **1**, use the spanner (included) to fully loosen all transit bolts by turning them counterclockwise.

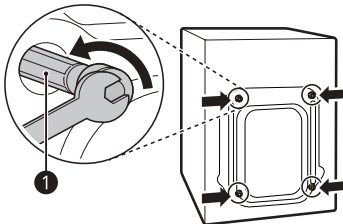

- 2 Remove the bolt assemblies by wiggling them slightly while pulling them out.
- 3 Install the hole caps.
 - Locate the hole caps **2** included in the accessory pack or attached on the back.

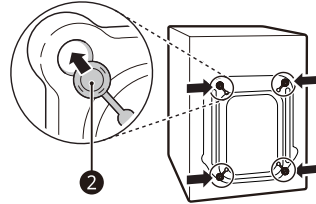

Levelling the Appliance

Checking the Level

Levelling the appliance prevents unnecessary noise and vibration. Check whether the appliance is perfectly level after installation.

- If the appliance rocks when pushing the top plate of the appliance diagonally, adjust the feet again.

Adjusting and Levelling the Feet

When installing the appliance, the appliance should be aligned and perfectly level.

- If the appliance is not aligned and level properly, the appliance may be damaged or may not operate properly.

1 Turn the adjustable feet as required if the floor is uneven.

- Do not insert pieces of wood etc. under the feet.
- Make sure that all four feet should be stable and resting on the floor.

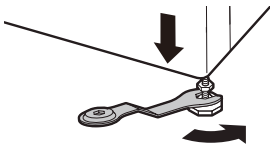
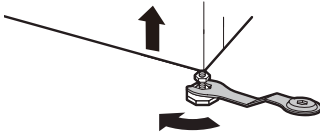

2 Check if the appliance is perfectly level using a spirit level **1**.

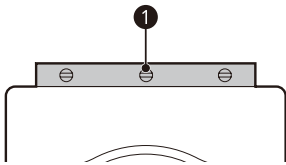

3 Secure the adjusting feet with the lock nuts **2** by turning counterclockwise against the bottom of the appliance.

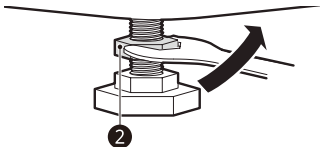

4 Check if all lock nuts at the bottom of the appliance are secured properly.

NOTE

- Proper placement and levelling of the appliance will ensure long, regular, and reliable operation.
- The appliance must be level and stand firmly in position.
- It must not 'Seesaw' across corners under the load.
- Do not let the feet of the appliance get wet. Failure to do so may cause vibration or noise.

Connecting the Water Inlet Hose

Note for Connection

- Water pressure must be between **100 kPa** and **1000 kPa** (1.0 - 10.0 kgf/cm²). If the water pressure is more than **1000 kPa**, a decompression device should be installed.
- Do not overtighten the water inlet hose to all valves.
- Periodically check the condition of the hose and replace the hose if necessary.

Checking the Rubber Seal on the Water Inlet Hose

Two rubber seals **1** are supplied with the water inlet hoses. They are used to prevent water leaks. Make sure that the connection to taps should be sufficiently tight.

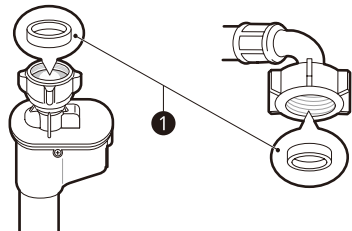
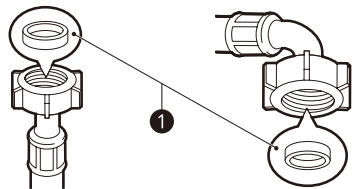

Connecting Hose to Water Tap

Screw - Type Hose to Tap with Thread

Screw the hose connector to the water supply, which has $\frac{3}{4}$ " threaded union.

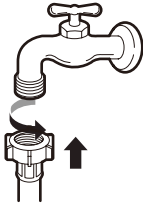

NOTE

- Before connecting the inlet hose to the water tap, turn on the water tap to flush out foreign substances (dirt, sand, sawdust, and etc.) in the water lines. Let the water drain into a bucket, and check the water temperature.

Connecting Hose to the Appliance

Screw the water line to the water supply on the back of the appliance.

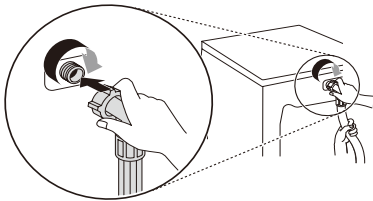

NOTE

- After completing connection, if water leaks from the hose, repeat the same steps. Use the most conventional type of tap for the water supply. If the tap is square or too big, remove the guide plate before inserting the tap into the adaptor.
- Make sure that the hose should not be kinked or trapped.

Installing the Drain Hose

For Model with Drain Pump

The drain hose should not be placed higher than **100 cm** above the floor. Water in the appliance may not drain or may drain slowly.

- Securing the drain hose correctly will protect the floor from damage due to water leakage.

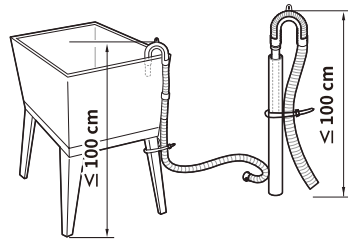
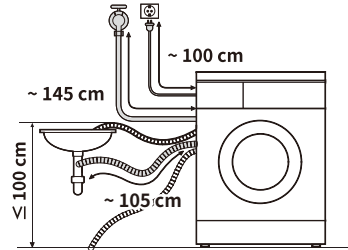

- If the drain hose is too long, do not force it back into the appliance. This will cause abnormal noise.
- When installing the drain hose to a sink, secure it tightly with string.

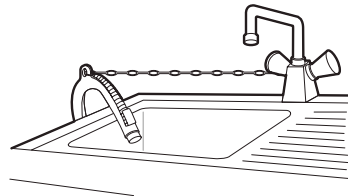

Operation Overview

Using the Appliance

Before the first wash, select the **Cotton** wash programme and add a half amount of the detergent. Start the appliance without laundry. This will remove possible residues and water from the drum that may have been left during manufacturing.

- 1 Sort laundry and load items.
 - Sort laundry by fabric type, soil level, colour and load size as needed. Open the door and load items into the appliance.
- 2 Add detergent or softener.
 - Add the proper amount of detergent to the detergent dispenser drawer. If desired, add bleach or fabric softener to the appropriate areas of the dispenser.
- 3 Turn on the appliance.
 - Press the **Power** button to turn on the appliance.
- 4 Choose the desired cycle.
 - Press the cycle button repeatedly or turn the cycle selector knob until the desired cycle is selected.
 - Now select a wash temperature and spin speed. Pay attention to a fabric care label of your clothes.
- 5 Begin cycle.
 - Press the **Start/Pause** button to begin the cycle. The appliance will agitate briefly without water to measure the weight of the load. If the **Start/Pause** button is not pressed within **15 minutes**, the appliance will shut off and all settings will be lost.
- 6 End of cycle.
 - When the cycle is finished, a melody will sound. Immediately remove your clothing from the appliance to reduce wrinkling. Check around the door seal when removing the load for small items that may be caught in the seal.

Preparing the Laundry

Sort laundry for best washing results, and then prepare laundry according to the symbols on the care labels.





Sorting the Clothes

- For best washing results, sort your clothes according to a care label stating fabric type and washing temperature. Adjust the spin speed to wash them.
- Soil level (Heavy, Normal, Light): Separate clothes according to soil level. If possible, do not wash heavily soiled items with lightly soiled ones.
- Colour (White, Lights, Darks): Wash separately dark or dyed clothes from whites or light colours. Mixing dyed clothes with light clothes can result in dye transfer or discolouration of lighter clothes.
- Lint (Lint producers, Collectors): Wash separately lint producing fabrics from lint collecting fabrics. Lint producers can result in pilling and linting on the lint collectors.

Checking the Fabric Care Label

Symbols on the care labels

The symbols tell you about the fabric content of your clothes and how it should be washed.

| Symbol | Wash / Fabric type |
|---|---|
|  | <ul style="list-style-type: none"> • Normal Wash • Cotton, Mixed Fabrics |
|  | <ul style="list-style-type: none"> • Easy Care • Synthetic, Mixed Fabrics |
|  | <ul style="list-style-type: none"> • Special Delicate Wash • Delicates |
|  | <ul style="list-style-type: none"> • Hand Wash Only • Wool, Silk |
|  | <ul style="list-style-type: none"> • Do not wash |

NOTE

- The dashes under the symbol give you information about the type of fabric and the maximum allowance of mechanical stress.

Checking the Clothes before Loading

- Combine large and small items in a load. Load large items first. Large items should not be more than half of total load.
- Do not wash single small items. Add 1-2 similar items to the load to prevent an out-of-balance load.
- Make sure to empty all pockets. Items such as nails, hair clips, matches, pens, coins and keys can damage both your appliance and clothes.

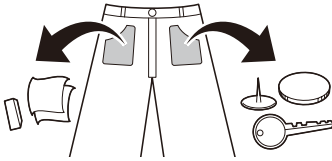

- Wash delicates (stockings, underwired bras) in a wash net.
- Close zippers, hooks and strings to make sure that these items do not snag other clothes.
- Pre-treat dirt and stains by saturating the dirt and stains with dissolved detergent and brushing them in order to remove dirt.
- Check the folds of the flexible gasket (gray) and remove any small items.

⚠ CAUTION

- Check if the laundry gets stuck between the door and the seal, otherwise the laundry may get damaged while washing.

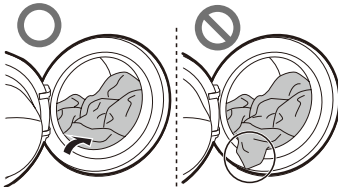

- Remove items from the flexible gasket to prevent clothing and door seal damage.

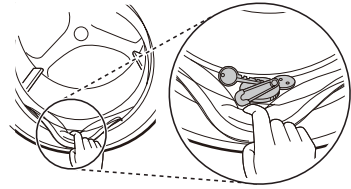

Adding Detergents and Softeners



Detergent Dosage

- Detergent should be used according to the instruction of the detergent manufacturer and selected according to type, colour, soiling of the fabric and the washing temperature.
- Reduce the amount of detergent if too many suds are formed.
- Too much detergent results in excessive suds which cause poor washing.
- When you use liquid detergent, follow the guidelines provided by the detergent manufacturer.
- You can pour liquid detergent directly into the main detergent drawer if you are starting the wash cycle immediately.
- Do not use liquid detergent if you are using **Delay End** function, or if you have selected **Pre Wash** option, as the liquid may harden.
- Detergent usage may need to be adjusted for water temperature, water hardness, size and soil level of the laundry. For best results, avoid oversudsing.
- Refer to the label of the clothes, before choosing the detergent and water temperature.
- Use only suitable detergents for the respective type of clothing:
 - Liquid detergent is often designed for special applications, e.g. for coloured fabric, wool, delicate or dark laundry.
 - Powdered detergent is suitable for all types of fabric.
 - For better washing results of white and pale clothes, use powdered detergent with bleach.
 - Detergent is dispensed from the dispenser at the beginning of the wash cycle.

NOTE

- Do not let the detergent harden. Doing so may lead to blockages, poor rinse performance or odour.
- Full load: According to manufacturer's recommendation
- Part load: $\frac{3}{4}$ of the normal amount
- Minimum load: $\frac{1}{2}$ of full load

Adding Detergent

- Detergent for main wash ① only → 
- Detergent for pre wash ② and main wash ① →  ● 

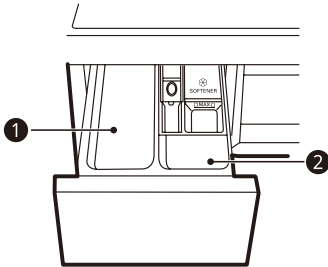
**NOTE**

- Use the appropriate amount of detergent. Too much detergent, bleach or softener may cause an overflow.
- When selecting **Pre Wash**, divide the dosage into $\frac{1}{3}$ for pre wash and $\frac{2}{3}$ for main wash.

Adding Detergent Tablet

Detergent tablet is also available when washing laundry.

- 1 Open the door and put detergent tablets into the drum.

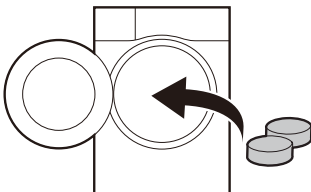

- 2 Load the laundry into the drum and close the door.

NOTE

- Do not put tablets into the drawer.

Adding Fabric Softener

- Add a fabric softener to the maximum fill line.

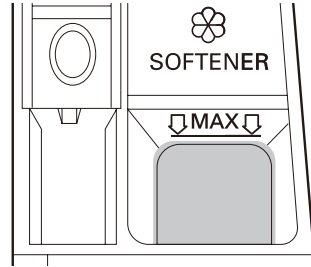

- Close the dispenser drawer gently.
- Do not leave the fabric softener in the detergent drawer for more than 2 days. Fabric softener may harden.
- Softener will automatically be added during the last rinse cycle.
- Do not open the drawer when water is being supplied.
- Solvents (e.g. benzene, etc.) must not be used.

NOTE

- Pouring excessive fabric softener over the maximum fill line can cause it to dispense too early, which may stain clothes.
- Do not pour fabric softener directly onto the laundry, which may stain the laundry.

Adding Water Softener

A water softener, such as anti-limescale can be used to cut down on the use of detergent in areas with high water hardness level.

- First add detergent, and then the water softener. Dispense according to the amount specified on the packaging.

Control Panel

Control Panel Features

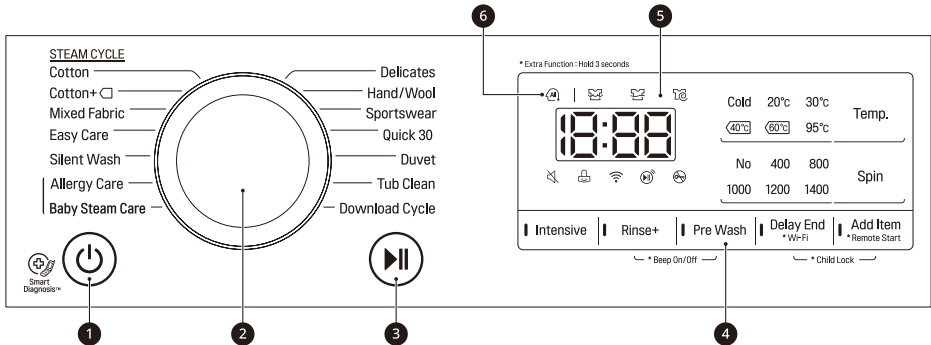

1 Power Button

- Press the **Power** button to turn on or off the appliance.

2 Programme Knob

- Programmes are available according to the laundry type.
- The lamp will light up to indicate the selected programme.

3 Start/Pause Button

- Press the **Start/Pause** button to start or pause a wash cycle.
- Press the **Start/Pause** button to stop a wash cycle temporarily.

4 Extra Options and Functions

- You can use the extra options and functions to customize the programmes.
- To use the extra functions, press and hold the corresponding button for 3 seconds. The corresponding symbol lights up in the display.
- In order to use the **Remote Start** function, refer to **SMART FUNCTIONS**.
- This allows you to select an additional programmes and will light when selected.
 - : This icon turns on when the appliance is connected to Wi-Fi network at home.

5 Display

- The display shows the settings, remaining estimated time, options, and status messages. When the appliance is turned on, the default settings in the display will light up.
 - : When a programme is selected, the default time for that programme is displayed. The default time can be changed according to the selected option.
 - : When the laundry is being washed, this icon is illuminated.
 - : When the laundry is being rinsed after completion of washing programme, this icon is illuminated.
 - : When the laundry is spun to remove the water in the laundry, this icon is illuminated.
 - : When this icon is illuminated, the door cannot be opened.

6 AI DD

- **AI DD** provides the desired washing and spinning.

-  is activated when **Cotton**, **Mixed Fabric** and **Easy Care** programmes are selected and operated.

Programme Table

Washing Programme

| Programme | Cotton | Max. Load | Rating |
|---------------------------|--|-----------|--------|
| Description | Provides better performance by combining various drum motions. Use for coloured fast items (shirts, nightdresses, pajamas, etc.) and normally soiled cotton load (underwear). | | |
| Proper Temperature | 40 °C (Cold to 95 °C) | | |
| Max. Spin Speed | 1400 rpm | | |

| Programme | Cotton+ | Max. Load | Rating |
|---------------------------|---|-----------|--------|
| Description | Provides optimised washing performance for large amount of laundry with less energy consumption. Use for coloured fast items (shirts, nightdresses, pajamas, etc.) and normally soiled cotton items (underwear). | | |
| Proper Temperature | 60 °C (Cold to 60 °C) | | |
| Max. Spin Speed | 1400 rpm | | |

| Programme | Mixed Fabric | Max. Load | 3 kg |
|---------------------------|--|-----------|------|
| Description | Enables various fabrics to be washed simultaneously. Use for various kind of fabrics except special items (silk/delicate, sports wear, dark clothes, wool, duvet/curtains). | | |
| Proper Temperature | 40 °C (Cold to 60 °C) | | |
| Max. Spin Speed | 1400 rpm | | |

| Programme | Easy Care | Max. Load | 3 kg |
|---------------------------|--|-----------|------|
| Description | Suitable for casual shirts that do not need ironing after washing. Use for Polyamide, acrylic, polyester. | | |
| Proper Temperature | 40 °C (cold to 60 °C) | | |
| Max. Spin Speed | 1400 rpm | | |

| | | | |
|---------------------------|--|------------------|--------|
| Programme | Silent Wash | Max. Load | 4.5 kg |
| Description | Provides less noise and vibration and saves money by using overnight electricity. Use for coloured fast garments (shirts, nightdresses, pajamas, etc.) and lightly soiled white cotton (underwear). | | |
| Proper Temperature | 40 °C (Cold to 60 °C) | | |
| Max. Spin Speed | 1000 rpm | | |

| | | | |
|---------------------------|--|------------------|--------|
| Programme | Allergy Care | Max. Load | 3.0 kg |
| Description | Helps to remove allergens such as house mites, pollen and fur. | | |
| Proper Temperature | 60 °C | | |
| Max. Spin Speed | 1400 rpm | | |

| | | | |
|---------------------------|---|------------------|--------|
| Programme | Baby Steam Care | Max. Load | 4.5 kg |
| Description | Provides clothes care with gentle motion and better performance by steam. | | |
| Proper Temperature | 60 °C | | |
| Max. Spin Speed | 1000 rpm | | |

| | | | |
|---------------------------|--|------------------|------|
| Programme | Delicates | Max. Load | 2 kg |
| Description | Suitable for delicate clothes such as underwear, blouse, etc | | |
| Proper Temperature | 20 °C (Cold to 40 °C) | | |
| Max. Spin Speed | 800 rpm | | |

| | | | |
|---------------------------|---|------------------|--------|
| Programme | Hand/Wool | Max. Load | 2.0 kg |
| Description | For hand and machine washable delicate clothes such as washable wool, lingerie, dresses etc. (Use detergent for machine washable woolens). Use for Wool, Silk, hand washable clothes, delicate, easily damaged laundry. | | |
| Proper Temperature | 30 °C (Cold to 40 °C) | | |
| Max. Spin Speed | 800 rpm | | |

| | | | |
|---------------------------|---|------------------|------|
| Programme | Sportswear | Max. Load | 3 kg |
| Description | Suitable for special items like sports and outdoor wear. Use for Coolmax, gore-tex, fleece and sympatex. | | |
| Proper Temperature | 40 °C (Cold to 40 °C) | | |
| Max. Spin Speed | 800 rpm | | |

| | | | |
|---------------------------|--|------------------|------|
| Programme | Quick 30 | Max. Load | 2 kg |
| Description | Provides fast washing time for small loads and lightly soiled clothes. | | |
| Proper Temperature | 20 °C (Cold to 40 °C) | | |
| Max. Spin Speed | 1400 rpm | | |

| | | | |
|---------------------------|---|------------------|--------------------|
| Programme | Duvet | Max. Load | 1 piece of laundry |
| Description | For large items such as bed covers, pillows, sofa covers, etc. Use for cotton bedding except special items (delicates, wool, silk, etc.) with filling: duvets, pillows, blankets, sofa covers with light filling. | | |
| Proper Temperature | Cold (Cold to 40 °C) | | |
| Max. Spin Speed | 1000 rpm | | |

| | | | |
|--------------------|---|--|--|
| Programme | Tub Clean | | |
| Description | This is a special function to clean inside of your appliance. | | |

| | | | |
|---------------------------|--|------------------|--------------------|
| Programme | Download Cycle | Max. Load | 1 piece of laundry |
| Description | The Download Cycle programme allows you to download new and special washing programs to your washing machine with a smartphone. The default program is on Rinse + Spin . | | |
| Proper Temperature | - | | |
| Max. Spin Speed | 1400 rpm | | |

NOTE

- Select the proper wash temperature and spin speed for the desired programmes.
- When washing, always pay attention to the care label of your clothes.
- Actual maximum spin speed may vary depending on the model, programme, and load conditions.

Extra Options

| Programme | Pre Wash | Delay End | Add Item | Rinse+ | Intensive |
|-----------------|----------|-----------|----------|--------|-----------|
| Cotton | ● | ● | ● | ● | ● |
| Cotton+ | ● | ● | ● | ● | |
| Mixed Fabric | ● | ● | ● | ● | ● |
| Easy Care | ● | ● | ● | ● | ● |
| Silent Wash | | ● | ● | ● | ● |
| Allergy Care | | ● | ● | ● | ● |
| Delicates | | ● | ● | ● | ● |
| Hand/Wool | | ● | ● | ● | ● |
| Sportswear | | ● | ● | ● | ● |
| Baby Steam Care | | ● | ● | ● | ● |
| Quick 30 | ● | ● | ● | ● | ● |
| Duvet | | ● | ● | ● | ● |
| Tub Clean | | | | | |
| Download Cycle | | ● | ● | ● | |

* This option is automatically inserted in the programme and cannot be deselected.

Consumption Data

Main Washing Programmes

| F*V509* | | | | | | |
|---------------|------------|-----------|-----------------|-----------|--------------|-----------------------|
| Programme | Temp. (°C) | Load (kg) | Duration (h:mm) | Water (L) | Energy (kWh) | Residual moisture (%) |
| Cotton+ □* | 60°C | 9 | 04:43 | 41 | 0.81 | 44 |
| | 60°C | 4.5 | 03:55 | 34 | 0.61 | 44 |
| | 40°C | 4.5 | 03:46 | 34 | 0.58 | 44 |

* The standard cotton programme is Cotton+ □, 60°C full load, Cotton+ □, 60°C half load, and Cotton+ 40°C half load in accordance with Regulations (EU) No. 1061/2010 and EN 60456.

NOTE

- The test results depend on water pressure, water hardness, water inlet temperature, room temperature, type and amount of laundry, type and amount of detergent and fluctuations in the main electricity supply and chosen additional options.
- Neutral detergent is recommended.
- The actual washing temperature may differ from the temperature of washing programmes stated in the table.

Extra Options and Functions

You can use the extra options and functions to customize the programmes.

Rinse

Use this option to select the number of rinse by pressing the **Rinse+** button. This option is recommended for people with detergent allergies.

Rinse+

Use this option to add rinse once.

Pre Wash

Use this option to wash the heavily soiled laundry.

- 1 Press the **Power** button.
- 2 Select a washing programme.
- 3 Press the **Pre Wash** button.
- 4 Press the **Start/Pause** button.

Intensive

Use this option to wash normally and heavily soiled laundry.

- 1 Press the **Power** button.
- 2 Select a washing programme.
- 3 Press the **Intensive** button for 3 seconds.
- 4 Press the **Start/Pause** button.

Delay End

Use this function to automatically start and finish the appliance after a specified time interval.

- 1 Press the **Power** button.
- 2 Select a washing programme.

- 3 Press the **Delay End** button to set a required time.

- 4 Press the **Start/Pause** button.

NOTE

- The delay time is the time to the end of the programme, not the start. The actual running time may vary due to water temperature, laundry and other factors.
- To cancel the function, the **Power** button should be pressed.
- Avoid using liquid detergent for this function.

Wi-Fi

When WLAN is connected, the **Wi-Fi** icon on the control panel is lit.

Add Item

Use this option to add or remove the laundry after the washing programme is started.

- 1 Press the **Add Item** button when the LED is turned on.
- 2 Open the door after it unlocks itself.
- 3 Add or remove laundry.
- 4 Close the door and press the **Start/Pause** button. NOTE
 - For safety reasons, the door remains locked when the water level or temperature inside of the drum is high. It is not possible to add laundry at this time.

Temp.

Use this option to select the wash and rinse temperature in combination for the selected programme. Press this button until the desired setting is lit. Cold tap water is used for all rinses.

- Select the water temperature suitable for the type of laundry you are washing. Follow the fabric care labels for best results.

Spin

Use this option to change the spin strength. Press the **Spin** button repeatedly to change the speed level.

- 1 Press the **Power** button.
- 2 Select a washing programme.
- 3 Press the **Spin** button to select spin speed.
- 4 Press the **Start/Pause** button.

NOTE

- When you select **No**, it will still rotate for a short time to drain quickly.

Beep On/Off

This function operates only when the appliance is in operation.

- Press and hold the **Rinse+** and **Pre Wash** button simultaneously for 3 seconds to set the this function.

NOTE

- Once this function is set, the setting is memorized even after the power is turned off.
- If you want to turn the beeper off, simply repeat this process.

Child Lock

Use this function to disable the controls. This function can prevent children from changing cycles or operating this appliance.

NOTE

- Once this function is set, all buttons are locked except the **POWER** button.
- When the controls are locked, **CL** and the remaining time are alternatively shown on the display during the wash while the child lock is engaged.
- Turning off the power will not reset this function. You must deactivate this function before you can access any other functions.



Locking the Control Panel

- 1 Turn on the power.
- 2 Press and hold the **Delay End** and **Add Item** button for 3 seconds to activate this function.
- A beeper will sound, and **CL** will appear on the display.

Unlocking the Control Panel

- 1 Turn on the power.
- 2 Press and hold the **Delay End** and **Add Item** button for 3 seconds to deactivate this function.

Using LG SmartThinQ Application

This feature is only available on the model with  or  logo.

Before Using LG SmartThinQ

- 1 Check the distance between the appliance and the wireless router (WLAN network).
 - If the distance between the appliance and the wireless router is too far, the signal strength becomes weak. It takes long time to register or fails to install the application.
- 2 Turn off the **Mobile data** or **Cellular Data** on your smartphone.

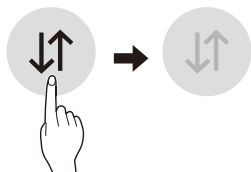

- 3 Connect your smartphone to the wireless router.

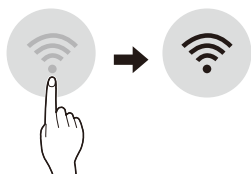

NOTE

- To verify the Wi-Fi connection, check that **Wi-Fi**  icon on the control panel is lit.
- The appliance supports 2.4 GHz Wi-Fi networks only. To check your network frequency, contact your internet service provider or refer to your wireless router manual.
- **LG SmartThinQ** is not responsible for any network connection problems or any faults, malfunctions, or errors caused by network connection.

- If the appliance is having trouble connecting to the Wi-Fi network, it may be too far from the router. Purchase a Wi-Fi repeater (range extender) to improve the Wi-Fi signal strength.
- The Wi-Fi may not connect or the connection may be interrupted because of the home network environment.
- The network connection may not work properly depending on the Internet service provider.
- The surrounding wireless environment can make the wireless network service run slowly.
- The appliance cannot be registered due to problems with the wireless signal transmission. Unplug the appliance and wait about a minute before trying again.
- If the firewall on your wireless router is enabled, disable the firewall or add an exception to it.
- The wireless network name (SSID) should be a combination of English letters and numbers. (Do not use special characters.)
- Smartphone user interface (UI) may vary depending on the mobile operating system (OS) and the manufacturer.
- If the security protocol of the router is set to **WEP**, you may fail to set up the network. Please change it to other security protocols (**WPA2** is recommended.) and register the product again.

Installing LG SmartThinQ

Search for the **LG SmartThinQ** application from the Google Play Store or Apple App Store on a smartphone. Follow instructions to download and install the application.

Wi-Fi Function

Communicate with the appliance from a smartphone using the convenient smart features.

Washer Cycle (Remote Start, Download Cycle)

Set or download any preferred cycle and operate by remote control.

Tub Clean Coach

This function shows how many cycles remain before running the **Tub Clean** cycle.

Energy Monitoring

Check the energy consumption of the recently used cycles and monthly average.

Smart Diagnosis

This function provides useful information for diagnosing and solving issues with the appliance based on the pattern of use.

Settings

Various functions are available.

Push Alert

This function is to inform the status notification so that the user can recognize the appliance status. The notifications are triggered even if the **LG SmartThinQ** application is off.

NOTE

- If you change your wireless router, internet service provider, or password, delete the registered appliance from the **LG SmartThinQ** application and register it again.
- The application is subject to change for the purpose of improving the appliance without notice to users.
- Functions may vary by model.

Using the Appliance Remotely

Remote Start

Use a smartphone to control your appliance remotely. You can also monitor your cycle operation so you know how much time is left in the cycle.

Using this function

- 1 Press the **Power** button.
- 2 Put the laundry into the drum.
- 3 Press and hold **Remote Start** button for 3 seconds to enable this function.

- 4 Start a cycle from the **LG SmartThinQ** application on your smartphone.

NOTE

- Once this function is enabled, you can start a cycle from the **LG SmartThinQ** smartphone application. If the cycle is not started, the appliance will wait to start the cycle until it is turned off remotely from the application or this function is disabled.
- When this function is turned on, the door is automatically locked.

Disabling This Function

When this function is activated, press and hold **Remote Start** button for 3 seconds to disable this function. This function must be turned off, so that the appliance can be used manually.

Download Cycle

Download a new and special cycle that is not included in the basic cycles on the appliance.

Appliances that have been successfully registered can download from a variety of specialty cycles specific to the appliance.

Only one cycle can be stored on the appliance at a time.

Once cycle download is completed in the appliance, the product keeps the downloaded cycle until a new cycle is downloaded.

Wireless LAN Module Specifications

| | |
|---------------------------|--|
| Model | LCW-004 |
| Frequency Range | 2412 to 2472 MHz |
| Output Power (Max) | IEEE 802.11b:17.82 dBm IEEE 802.11g:17.72 dBm IEEE 802.11n:16.61 dBm |

Wireless function S/W version: V 1.0

For consideration of the user, this device should be installed and operated with a minimum distance of 20 cm between the device and the body.

Declaration of Conformity



Hereby, LG Electronics declares that the radio equipment type Washing Machine is in compliance with Directive 2014/53/EU. The full text of the EU declaration of conformity is available at the following internet address:

<http://www.lg.com/global/support/cedoc/cedoc#>



LG Electronics European Shared Service Centre
B.V

Krijgsman 1

1186 DM Amstelveen

The Netherlands

Smart Diagnosis Using a Smartphone

This feature is only available on the model with  or  logo.

Use this function if you need an accurate diagnosis by an LG Electronics customer information centre when the appliance malfunctions or fails.

This function cannot be activated unless the appliance is connected to power. If the appliance is unable to turn on, then troubleshooting must be done without using this function.

Standby Power Consumption

| | |
|--|---------|
| Standby power consumption | 0.5 W |
| Network standby power consumption | 2.0 W |
| The period of time after which the power management function, or a similar function, switches the equipment automatically into standby and/or off mode and/or the condition providing networked standby | 20 min. |

Open Source Software Notice Information

To obtain the source code under GPL, LGPL, MPL, and other open source licenses, that is contained in this product, please visit <http://opensource.lge.com>.

In addition to the source code, all referred license terms, warranty disclaimers and copyright notices are available for download.

LG Electronics will also provide open source code to you on CD-ROM for a charge covering the cost of performing such distribution (such as the cost of media, shipping, and handling) upon email request to opensource@lge.com.

This offer is valid for a period of three years after our last shipment of this product. This offer is valid to anyone in receipt of this information.

Using Smart Diagnosis

Smart Diagnosis Through the Customer Information Centre

Use this function if you need an accurate diagnosis by an LG Electronics customer information centre when the appliance malfunctions or fails. Use this function only to contact the service representative, not during the normal operation.

- 1 Press the **Power** button to turn on the appliance.
 - Do not press any other buttons.
- 2 When instructed to do so by the call centre, place the mouthpiece of your phone close to the **Smart Diagnosis** icon.

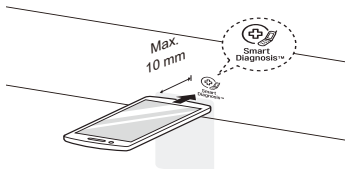

- 3 Press and hold the **Temp.** button for 3 seconds.
- 4 Keep the phone in place until the tone transmission has finished. Time remaining for data transfer is displayed.
 - For best results, do not move the phone while the tones are being transmitted.
 - If the call centre agent is not able to get an accurate recording of the data, you may be asked to try again.
- 5 Once the countdown is over and the tones have stopped, resume your conversation with the call centre agent, who will then be able to assist you using the information transmitted for analysis.

NOTE

- This function depends on the local call quality.
- The communication performance will improve and you can receive better service if you use the home phone.

- If the data transfer is poor due to poor call quality, you may not receive the best diagnosis service.

! WARNING

- Unplug the appliance before cleaning to avoid the risk of electric shock. Failure to follow this warning may result in serious injury, fire, electric shock, or death.
- Never use harsh chemicals, abrasive cleaners, or solvents to clean the appliance. They may damage the finish.

Cleaning After Every Wash

Care After Wash

- After the wash cycle is finished, wipe the door and door seal to remove any moisture.
- Leave the door slightly open to dry the drum.
- Wipe the appliance with a dry cloth to remove any moisture.

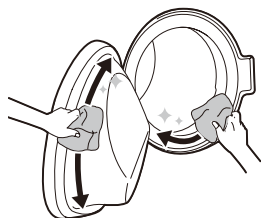

! WARNING

- Leave the door open to dry the drum interior but only if it is safe and any children are supervised.

Cleaning the Exterior

Proper care of the appliance can extend the service life.

Exterior

- Immediately wipe off any spills. Wipe with a damp cloth.
- Wipe with a damp cloth and then again with a dry cloth ensuring there is no moisture in cabinet joints or crevices.
- Do not press on the surface on the display with sharp objects.

Door

- Wash with a damp cloth on the outside and inside and then dry with a soft cloth.

! WARNING

- Do not attempt to separate any panels or disassemble the appliance. Do not apply any sharp objects to the control panel in order to operate the appliance.

Cleaning the Interior

- Use a towel or soft cloth to wipe around the door opening and door glass.
- Always remove items from the appliance as soon as the cycle is complete. Leaving damp items in the appliance can cause wrinkling, colour transfer, and odour.

Cleaning the Appliance Periodically

Tub Clean

Use this function to clean inside of the appliance.

A higher water level is used in this programme at higher spin speed. Run this function once a month (or more often if needed) to remove detergent buildup and other residue.

- 1 Remove any clothing or items from the appliance and close the door.
- 2 Open the dispenser drawer and add anti-limescale powder to the main wash compartment.
 - Put tablets into the drum.
- 3 Close the dispenser drawer slowly.
- 4 Turn on the power, and then select the **Tub Clean**.
 - ECL will be displayed on the display.
- 5 Press the **Start/Pause** button to start.
- 6 After the programme is complete, leave the door open to dry the door opening, gasket, and door glass.

WARNING

- Leave the door open to dry inside of the appliance only if the children are supervised at home.

Cleaning the Water Inlet Filter

Water inlet filter collects lime or any small objects that may be in water supplied to the appliance. Clean the water inlet filter regularly.

NOTE

- Turn off the supply tap to the appliance if the appliance is to be left for a certain period of time (e.g. holiday), especially if there is no floor drain (gully) in the immediate vicinity.
- E error message will be displayed on the control panel when water is not entering the detergent drawer.
- If the water is very hard or contains traces of limescale, the filter on the water inlet may be clogged.

- 1 Turn off the water tap and unscrew the water inlet hose.

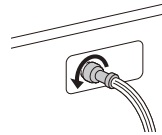

- 2 Clean the filter using a medium bristle tooth brush.

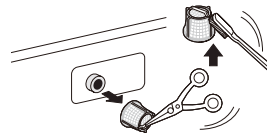

Cleaning the Drain Pump Filter

The drain filter collects threads and small objects left in the laundry. Check regularly that the filter is clean to ensure smooth running of your appliance.

Allow the water to cool before cleaning the drain pump filter. Open the door in an emergency or perform a emergency evacuation.

- 1 Unplug the appliance.
- 2 Open the cover cap and pull out the hose.

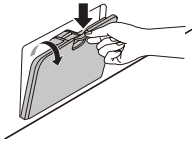

- 3 Unscrew the drain plug ①, and then drain the water. Slowly unscrew the drain pump filter ② to drain the water and remove small objects.

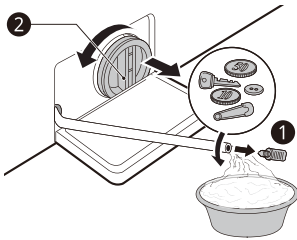

- 4 After cleaning the drain pump filter, take the drain pump filter out and insert the drain plug.
- 5 Close the cover cap.

⚠ CAUTION

- Be careful when draining, as the water may be hot.
- Run the drum cleaning programme once a month (or more often, as needed) to remove excess detergent and other debris.

Cleaning the Dispenser Drawer

Detergent and fabric softener may build up in the dispenser drawer. Remove the drawer and the components of the drawer in the drawer and check for build-up of detergents or softeners once or twice a month.

- 1 Remove the detergent dispenser drawer by pulling the drawer straight out until the drawer stops.
 - Remove the drawer while pressing the release button on the inside of the detergent drawer.

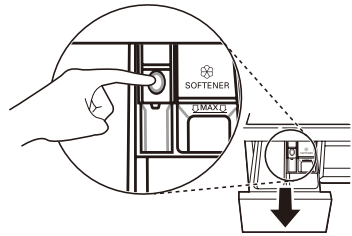

- 2 Remove the build-up of detergent and softener.
 - Rinse the drawer and the components of the drawer with warm water to remove the build-up from detergent and softener. Use only water to clean the dispenser drawer. Dry the drawer and the components of the drawer with a soft cloth or towel.
- 3 To clean the drawer opening, use a cloth or small, non-metal brush to clean the recess.
 - Remove all residue from the upper and lower parts of the recess.
- 4 Wipe any moisture off the detergent drawer recess with a soft cloth or towel.
- 5 Re-assemble the components of the drawer to the proper compartments and insert the drawer.

Before Calling for Service

Operation of the appliance can lead to errors and malfunctions. The following tables contain possible causes and notes for resolving an error message or malfunction. You can remedy most of the problems by yourself, consequently save time and money, since you do not need to call LG Electronics service centre. The following table should assist you by troubleshooting.

Error Messages

The appliance is equipped with an automatic error-monitoring system to detect and diagnose problems at an early stage. If this appliance does not function properly or does not function at all, check the following before you call LG Electronics service centre.

| Symptoms | Possible Cause & Solution |
|--------------------------|---|
| IE INLET ERROR | Water supply is not adequate in that location. Water does not enter appliance or it enters slowly. <ul style="list-style-type: none"> • Check another tap in the house. |
| | Water supply tap is not completely open. Water does not enter the appliance or it enters slowly. <ul style="list-style-type: none"> • Open fully tap. |
| | Water supply hose(s) are kinked. <ul style="list-style-type: none"> • Straighten hose or reinstall the water inlet hose |
| | The filter of the supply hose(s) are clogged. <ul style="list-style-type: none"> • Check and clean the filter of the inlet hose. |
| | If water leakage occurs in the aqua stop supply hose, indicator will become red. <ul style="list-style-type: none"> • Replace the aqua stop supply hose. |
| OE WATER OUTLET ERROR | Drain hose is kinked or clogged. Water in the appliance does not drain or drains slowly. <ul style="list-style-type: none"> • Clean and straighten the drain hose. |
| | The drain filter is clogged. <ul style="list-style-type: none"> • Check and clean the drain filter. |
| UE UNBALANCE ERROR | The appliance has a system which detects and corrects the unbalance of the appliance. <ul style="list-style-type: none"> • The laundry may be too wet at the end of the cycle, rearrange the laundry to allow proper spinning. Close the door and press Start/Pause button. It may take a few moments before the appliance begins to spin. The door must be locked before spin can be achieved. |
| | Load is too small. This system may stop spinning or even interrupt the spin cycle altogether if individual heavy items (e.g. bath mat, bath robe, etc.) are loaded. <ul style="list-style-type: none"> • Add 1 or 2 similar items or items to help balance the laundry. Close the door and press Start/Pause button. It may take a few moments before the appliance begins to spin. The door must be locked before spin can be achieved. |

| Symptoms | Possible Cause & Solution |
|-------------------------------------|--|
| dE dE1 dE2 dE4 DOOR ERROR | Door sensor malfunctions. <ul style="list-style-type: none"> • Please call LG Electronics service centre. You can find your local LG Electronics service centre phone number in the warranty card. |
| tE CONTROL ERROR | This is a control error. <ul style="list-style-type: none"> • Unplug the power plug and call for service. |
| LE MOTOR LOCKED ERROR | Over load in motor <ul style="list-style-type: none"> • Let the appliance wait for 30 minutes until the motor is cooled down and then, restart the cycle |
| FE OVERFLOW ERROR | Water overfills due to the faulty water valve. <ul style="list-style-type: none"> • Close the water tap. • Unplug the power plug. • Call for service. |
| PE PRESSURE SENSOR ERROR | Water level sensor malfunctions. <ul style="list-style-type: none"> • Close the water tap. • Unplug the power plug. • Call for service. |
| uS VIBRATION SENSOR ERROR | Vibration sensor malfunctions. <ul style="list-style-type: none"> • Call for service. |
| FF FROZEN FAILURE | Is supply/drain hose or drain pump frozen? <ul style="list-style-type: none"> • Supply warm water into the drum in order to unfreeze the drain hose and the drain pump. Cover the supply hose with wet and warm towel. |
| RE WATER LEAKAGE | Water leaks. <ul style="list-style-type: none"> • Call for service. |
| PF POWER FAILURE | The appliance experienced a power failure. <ul style="list-style-type: none"> • Restart the cycle. |



Noises You Might Hear

| Symptoms | Possible Cause & Solution |
|------------------------------------|--|
| Rattling and clanking noise | Foreign objects, such as keys, coins, or safety pins may be in the drum. <ul style="list-style-type: none"> • Stop the appliance, check the drum for foreign objects. If the noise continues after the appliance is restarted, call for service. |
| Thumping sound | Heavy laundry may produce a thumping sound. This is usually normal. <ul style="list-style-type: none"> • If the sound continues, the appliance is probably out of balance. Stop and redistribute the laundry. |
| | The laundry may be out of balance. <ul style="list-style-type: none"> • Pause the cycle and redistribute the laundry after the door unlocks. |
| Vibrating noise | Package materials are not removed. <ul style="list-style-type: none"> • Remove package materials. |

| Symptoms | Possible Cause & Solution |
|----------|---|
| | The laundry may be unevenly distributed in the drum. <ul style="list-style-type: none"> • Pause the cycle and redistribute the laundry after the door unlocks. |
| | Not all leveling feet are resting firmly and evenly on the floor. <ul style="list-style-type: none"> • See the Leveling the Appliance to adjust the leveling of the appliance. |
| | Floor not rigid enough. <ul style="list-style-type: none"> • Check if the floor is solid and does not flex. See the Installation Place Requirements to select the proper location. |

Operation

| Symptoms | Possible Cause & Solution |
|------------------------------------|---|
| Water is leaking. | House drain pipes are clogged. <ul style="list-style-type: none"> • Unclog the drain pipe. Contact plumber if necessary. |
| | Leakage is caused by improper installation of drain hose or clogged drain hose. <ul style="list-style-type: none"> • Clean and straighten the drain hose. Check and clean the drain filter regularly. |
| Appliance does not operate. | Control panel has powered off due to inactivity. <ul style="list-style-type: none"> • This is normal. Press the Power button to turn the appliance on. |
| | Appliance is unplugged. <ul style="list-style-type: none"> • Make sure that the cord should be plugged securely into a working outlet. |
| | Water supply is turned off. <ul style="list-style-type: none"> • Turn the water supply tap completely. |

| Symptoms | Possible Cause & Solution |
|---|---|
| Appliance does not operate. | Controls are not set properly. <ul style="list-style-type: none"> • Make sure that the cycle should be correctly set. Close the door and press the Start/Pause button. |
| | Door is open. <ul style="list-style-type: none"> • Close the door and make sure that nothing should be caught under the door preventing it from closing completely. |
| | Circuit breaker/fuse is tripped/blown. <ul style="list-style-type: none"> • Check house circuit breakers/fuses. Replace fuses or reset breaker. The appliance should be on a dedicated branch circuit. The appliance will resume the cycle where it stopped once power is restored. |
| | Control needs to be reset. <ul style="list-style-type: none"> • Press the Power button, then reselect the desired programme and press the Start/Pause button. |
| | Start/Pause was not pressed after a cycle was set. <ul style="list-style-type: none"> • Press the Power button, then reselect the desired programme and press the Start/Pause button. The appliance is turned off if the Start/Pause button is not pressed within 15 minutes. |
| | Extremely low water pressure. <ul style="list-style-type: none"> • Check another tap in the house to make sure that household water pressure should be adequate. |
| | Appliance is heating the water or making steam. <ul style="list-style-type: none"> • The drum may stop operating temporarily during certain cycles, while water is safely heated to a set temperature. |
| Buttons may not function properly. | The door cannot be opened for safety reasons once the appliance starts. <ul style="list-style-type: none"> • Check if the  is illuminated. You can safely open the door after the Door Lock icon turns off. |
| Door does not open. | The door cannot be opened for safety reasons once the appliance starts. <ul style="list-style-type: none"> • Check if the  icon is illuminated. You can safely open the door after the  icon turns off. |
| Appliance is not filling properly. | Filter clogged. <ul style="list-style-type: none"> • Make sure the inlet filters on the fill valves are not clogged. |
| | Inlet hoses may be kinked. <ul style="list-style-type: none"> • Check that inlet hoses are not kinked or clogged. |
| | Insufficient water supply. <ul style="list-style-type: none"> • Make sure that both hot and cold water taps should be turned on all the way. |
| | Hot and cold inlet hoses are reversed. <ul style="list-style-type: none"> • Check inlet hose connections. |

| Symptoms | Possible Cause & Solution |
|--|--|
| Appliance does not drain water. | Kinked drain hose. <ul style="list-style-type: none"> Ensure that the drain hose is not kinked. |
| | Drain located higher than 1.2 m above the floor. <ul style="list-style-type: none"> Make sure that the drain hose should not be higher than 1.2 m above the bottom of the appliance. |
| Detergent is not dispensed incompletely or not dispensed at all. | Too much detergent is used. <ul style="list-style-type: none"> Follow the guidelines provided by the detergent manufacturer. |
| Cycle time is longer than usual. | The load is too small. <ul style="list-style-type: none"> Add more items to allow the appliance to balance the laundry. |
| | Heavy items are mixed with lighter items. <ul style="list-style-type: none"> Always try to wash items with similar weight in order to allow the appliance to evenly distribute the weight of the laundry for spinning. |
| | The load is out of balance. <ul style="list-style-type: none"> Manually redistribute the laundry if items have become tangled. |
| Duration is delayed | Unbalance is detected or suds removing programme is on. <ul style="list-style-type: none"> This is normal. The time remaining shown on the display is only an estimated duration. Actual time may vary. |

Performance

| Symptoms | Possible Cause & Solution |
|--------------------|--|
| Poor stain removal | Previously set stains. <ul style="list-style-type: none"> Items that have been previously washed may have stains which have been set. These stains may be difficult to remove and may require hand washing or pre-treating to aid in stain removal. |
| Staining | Bleach or softener is dispensed too soon. <ul style="list-style-type: none"> Dispenser compartment is overfilled. It makes bleach or softer dispensed rapidly. Always measure bleach or softener to prevent overfilling. Close the dispenser drawer gently. |
| | Bleach or softener was added directly to the laundry in the drum. <ul style="list-style-type: none"> Always use the dispensers to ensure that laundry products are properly dispensed at the right time in the cycle. |
| | Clothes were not properly sorted. <ul style="list-style-type: none"> Always wash dark colours separately from light colours and whites to prevent discolouration. Never wash heavily soiled items with lightly soiled items. |

| Symptoms | Possible Cause & Solution |
|--|--|
| Wrinkling | Appliance is not unloaded promptly. <ul style="list-style-type: none"> • Always remove items from the appliance as soon as the cycle is complete. |
| | Appliance is overloaded. <ul style="list-style-type: none"> • The appliance can be fully loaded, but the drum should not be tightly packed with items. The door of the appliance should be closed easily. |
| | Hot and cold water inlet hoses are reversed. <ul style="list-style-type: none"> • Hot water rinse can set wrinkles in garments. Check the inlet hose connections. |
| Musty or mildewy odour in appliance | Inside of drum is not cleaned properly. <ul style="list-style-type: none"> • Run the Tub Clean function regularly. |
| | The drain hose is not properly installed, causing siphoning (water flowing back inside of the appliance). <ul style="list-style-type: none"> • When installing the drain hose, make sure that it does not get kinked or blocked. |
| | The detergent dispenser drawer is not cleaned regularly. <ul style="list-style-type: none"> • Clean the detergent dispenser drawer, especially the top and the bottom of the drawer's opening. |
| | Odours can occur if the drain hose is not properly installed, causing siphoning (water flowing back inside of the appliance). <ul style="list-style-type: none"> • When installing the drain hose, make sure that it does not get kinked or blocked. |
| | If the detergent dispenser drawer is not cleaned regularly, odours can occur from mold or foreign substances. <ul style="list-style-type: none"> • Clean the detergent dispenser drawer, especially the top and bottom of the drawer's opening. |

Wi-Fi

| Symptoms | Possible Cause & Solution |
|--|--|
| <p>Your home appliance and smart phone is not connected to the Wi-Fi network.</p> | <p>The password for the Wi-Fi that you are trying to connect to is incorrect.</p> <ul style="list-style-type: none"> Find the Wi-Fi network connected to your smartphone and remove it, then register your appliance on LG SmartThinQ. |
| | <p>Mobile data for your smartphone is turned on.</p> <ul style="list-style-type: none"> Turn off the Mobile data of your smartphone and register the appliance using the Wi-Fi network. |
| | <p>The wireless network name (SSID) is set incorrectly.</p> <ul style="list-style-type: none"> The wireless network name (SSID) should be a combination of English letters and numbers. (Do not use special characters). |
| | <p>The router frequency is not 2.4 GHz.</p> <ul style="list-style-type: none"> Only a 2.4 GHz router frequency is supported. Set the wireless router to 2.4 GHz and connect the appliance to the wireless router. To check the router frequency, check with your internet service provider or the router manufacturer. |
| | <p>The distance between the appliance and the router is too far.</p> <ul style="list-style-type: none"> If the distance between the appliance and the router is too far, the signal may be weak and the connection may not be configured correctly. Move the location of the router so that it is closer to the appliance. |

Product Fiche

Commission Delegated Regulation (EU) No 1061/2010

| | | |
|---|-------------------------|---------|
| Supplier's name or trade mark | LG | |
| Supplier's model | | F*V509* |
| Rated capacity | kg | 9 |
| Energy efficiency class | | A+++ |
| Awarded an "EU Ecolabel award" under regulation [(EC) No 66/2010] | | No |
| Weighted annual energy consumption (AEC) kWh per year ¹ | kWh/year | 152 |
| Energy consumption | | |
| The standard 60 °C cotton programme at full load | kWh | 0.81 |
| The standard 60 °C cotton programme at partial load | kWh | 0.61 |
| The standard 40 °C cotton programme at partial load | kWh | 0.58 |
| Weighted power consumption of the off-mode and of the left-on mode | W | 0.45 |
| Weighted annual water consumption (AWC) in litres per year ² | litres/year | 8800 |
| Spin-drying efficiency class on a scale from G (least efficient) to A (most efficient). | | A |
| Maximum spin speed ³ | rpm | 1360 |
| Remaining moisture ³ | % | 44 |
| The standard cotton programmes ⁴ | Cotton+□, 60 °C / 40 °C | |
| The programme time | | |
| The standard 60 °C cotton programme at full load ⁵ | min. | 283 |
| The standard 60 °C cotton programme at partial load ⁵ | min. | 235 |
| The standard 40 °C cotton programme at partial load ⁵ | min. | 226 |
| The duration of the left-on mode (TI) | min. | 10 |
| Airborne acoustical noise emissions | | |
| Washing phase ⁶ | dB(A) | 52 |
| Spinning phase ⁶ | dB(A) | 75 |
| Free-Standing | | |

- *1: Based on 220 standard washing cycles for cotton programmes at 60 °C and 40 °C at full and partial load, and the consumption of the low-power modes. Actual energy consumption will depend on how the appliance is used.
- *2: Based on 220 standard washing cycles for cotton programmes at 60 °C and 40 °C at full and partial load. Actual water consumption will depend on how the appliance is used.
- *3: Attained for the standard 60 °C cotton programme at full load or the standard 40 °C cotton programme at partial load, whichever is the lower, and remaining moisture content attained for the standard 60 °C cotton programme at full load or the standard 40 °C cotton programme at partial load, whichever is the greater.
- *4: To which the information in the label and in the fiche relates, that these programmes are suitable to clean normally soiled cotton laundry and that they are the most efficient programmes in terms of combined energy and water consumption.
- *5: The standard cotton programme is **Cotton+** , ^{60°C} full load, **Cotton+** , ^{60°C} half load, and **Cotton+** half load in accordance with Regulations (EU) No. 1061/2010 and EN 60456.
- *6: Expressed in dB(A) re 1 pW and rounded to the nearest integer during the washing and spinning phases for the standard 60 °C cotton programme at full load.

Memo

Memo

Memo

