



16+
age

Instructions For Use

Gebrauchsanweisung

V 1.0

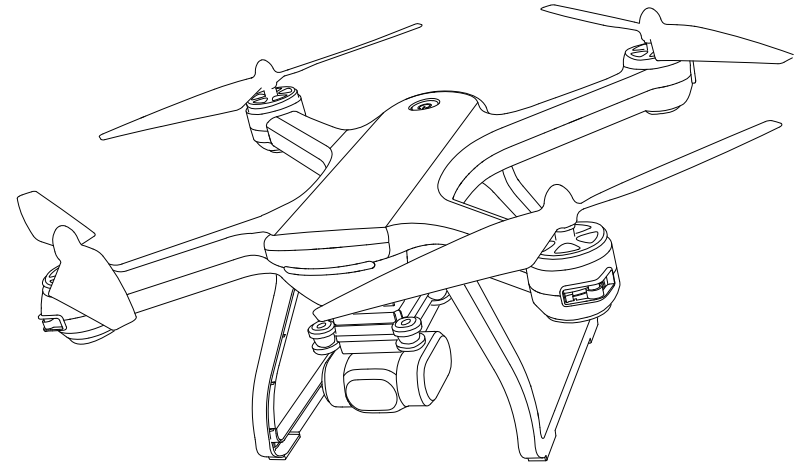

HS700D-4K

 +1(855) 888-6699

 www.holystone.com

 usa@holystone.com (USA)
ca@holystone.com (CA)

eu@holystone.com (EU)

English 01-41

Deutsch 42-80

Contents

1.0 Disclaimer&Warning	1	10.0 Functions Details	
2.0 Safety Guidelines	1	10.1 Transmitter Calibration	22
3.0 Maintenance	5	10.2 Headless Mode	23
4.0 Package Contents	6	10.3 Return to Home	24
5.0 Installation		10.4 Camera Angle Adjustment	26
5.1 Phone Holder	7	11.0 Drone Status Indicator	27
5.2 Camera	7	12.0 APP Operation Instruction	
5.3 Landing Gear	8	12.1 Operation Interface	28
5.4 Propeller Guard & Dust Cover	9	12.2 Follow Me	29
5.5 Propellers	10	12.3 Point of Interest	30
6.0 Drone's Details	10	12.4 TapFly	31
7.0 Transmitter Details		12.5 Take Photo/ Video	32
7.1 Transmitter Functions	11	13.0 Specifications	33
7.2 LCD Screen Functions	12	14.0 Trouble Shooting	34
7.3 Mode Switch	13	15.0 Contact Us	36
8.0 Charging	14	16.0 General Information	36
9.0 Operation Guide			
9.1 Download APP	15		
9.2 Transmitter's Battery	15		
9.3 Drone's Battery	16		
9.4 Paring	17		
9.5 Initialization Detection	17		
9.6 Compass Calibration	18		
9.7 Using the Application	19		
9.8 Unlock	20		
9.9 One Key Takeoff / Landing	21		
9.10 Flight Control	21		

1.0 DISCLAIMER & WARNING

1. Please read this Disclaimer & Warning and Safety Guidelines carefully before using our product. This product is not recommended for people under the age of 16. By using this product, you hereby agree to this disclaimer and signify that you have read it fully. You agree that you are responsible for your own conduct and any damaged caused while using this product, and its consequences. You agree to use this product only for purposes that are proper and in accordance with local regulations, terms and all applicable polices and guidelines Holy Stone may make available.

2. When using this product, please be sure to strictly abide by the specification requirements and safety guidelines stated in this document. Any personal injury property damage, legal disputes and all other adverse events caused by the violation of the safety instructions or due to any other factor, WILL NOT be Holy Stone's responsibility.

2.0 SAFETY GUIDELINES

2.1 Check Before Use:

- ① This product is a high precision drone that integrates various electronic stability and control mechanisms. Please be sure to setup this drone carefully and correctly to ensure safe, accident-free operation.
- ② Please be sure that the batteries of the drone and transmitter are clean, undamaged and, fully charged.
- ③ Please be sure that all the propellers are undamaged and are installed in the correct orientation.

④ Please do a thorough check of the product before each use. Check for firmness of the parts, any signs of cracks and wear of the propeller, battery power and effectiveness of the indicator, etc. If after doing a complete check any issues are found, please refrain from using the product until the issue has been resolved.

2.2 Flight Environment:

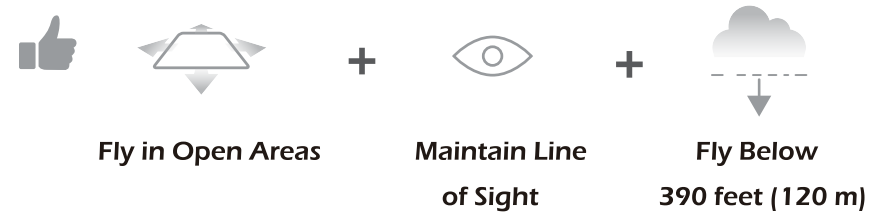

Avoid flying over or near obstacles, crowds, high voltage power lines, trees, airport or bodies of water.

DO NOT fly near strong electromagnetic sources such as power lines and base stations as it may affect the onboard compass.



Don't use this drone in adverse weather conditions such as rain, snow, fog, and wind.

2.3 Operations Requirements:

- ① Please don't use this product to follow any moving vehicles .
- ② During the flight, only turn off the motor in case of an emergency.
- ③ Please flight the drone back to you as soon as possible when the battery is running low.
- ④ This product should not be used while drinking alcohol, if you are feeling fatigued, taking medicine, or feeling any physical discomfort.
- ⑤ Beware of the noise volume the drone produces. Keep your distance to avoid ear damage.





- ⑥ **Stay away from the rotating propellers and motors.**
- ⑦ **Don't fly in the No-Fly Zone.**

2.4 Use of Battery:

- ① Please ensure batteries are fitted in the correct orientation as shown in the instruction manual.
- ② Avoid short circuits by fitting the batteries correctly, and do not crush or squeeze the batteries as this could carry the risk of an explosion.
- ③ Do not mix new and old batteries as this can lead to a poor performance of the product.
- ④ Dispose used batteries carefully, do not litter.
- ⑤ Please keep dead batteries away from heat and fire.
- ⑥ If the device is not going to be used for an extended period of time, remove batteries to prevent potential damage from battery leakage.











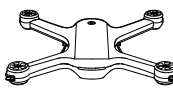

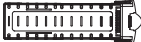
- ⑦ It is recommended to only use the USB charging cable that comes with the drone to charge the battery.
- ⑧ Don't connect the battery directly to wall outlets or car cigarette-lighter sockets.
- ⑨ Don't attempt to disassemble or modify the battery in any way.
- ⑩ Don't use the battery if it gives off an odor, generates heat, becomes discolored or deformed, or appears abnormal in any way. If the battery is in use or being charged, remove it from the device or charger immediately and discontinue use.
- ⑪ Don't pierce the battery casing with a nail or other sharp object, break it open with a hammer, or step on it!
- ⑫ Always charge the batteries in a fireproof container and away from combustible materials. Don't charge on surfaces that can catch fire. This includes: wood, cloth, carpet, or in the application's device.
- ⑬ Don't immerse the battery in water or allow it to get wet.
- ⑭ Don't solder battery terminal directly.
- ⑮ Keep battery out of reach of children or pets.
- ⑯ Don't short-circuit the battery by connecting wires or other metal object to the positive(+) and negative(-) terminals.

	Li-Po Battery Disposal & Recycling Waste Lithium-polymer batteries must not be placed with household trash. Please contact local environmental or waste agency or the waste agency or the supplier of your model or your nearest Li-Po battery recycling center.	
---	--	---

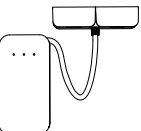
3.0 MAINTENANCE

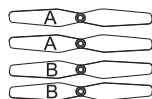
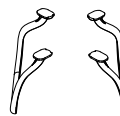
- ① Clean the product after each use with a clean, soft cloth.
- ② Avoid prolonged exposure to direct sunlight and avoid buildup of heat on the drone.
- ③ This device is not waterproof and must not be submerged in water under any circumstance. Failure to maintain the device completely dry will result in the failure of the unit.
- ④ Check the charging plug and other accessories for signs of damage frequently. If any part of the device is damaged, refrain from flying until maintenance can be carried out.

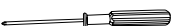
4.0 PACKAGE CONTENTS

 × 1	 × 1	 × 1	 × 1
Drone	Transmitter	Drone Battery	Phone Holder
 × 1	 × 1	 × 1	 × 1
Camera	USB Data Cable	Battery Charger Hub	USB Charging Cables
 × 2	 × 2	 × 4	 × 4
Propellers	Landing Gear	Propeller Guard	Dust Cover
 × 1	 × 1	 × 1	
Screwdriver	Propeller Spanner	Instructions For Use	

5.0 INSTALLATION

5.1 Phone Holder

① As shown in the picture, connect the phone holder to the transmitter. (Pic 1)

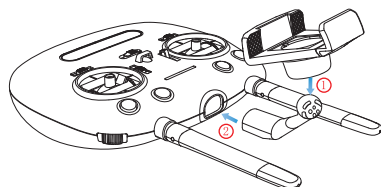

Pic 1

② Press the buckle on the phone holder to remove it. (Pic 2)

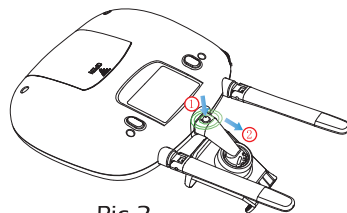

Pic 2

5.2 Camera

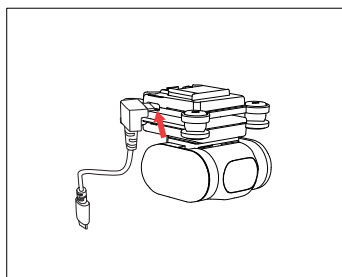

Pic 3

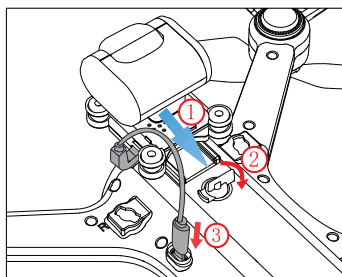

Pic 4

① Connect the USB data cable to the camera. (Pic 3)

② Install and lock the camera on the drone, and then connect the USB data cable to the drone. (Pic 4)

5.3 Landing Gear

① Insert the "A" side of the landing gear to the "A" hole on the drone. (Pic 5)

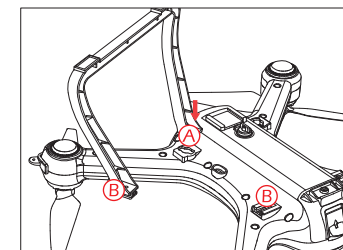

Pic 5

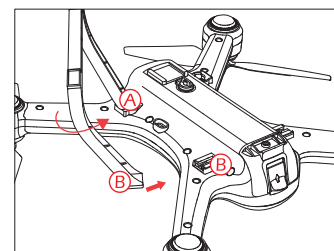

Pic 6

② Rotate the landing gear inward, then push the "B" side of landing gear into the "B" hole on the drone to complete installation. (Pic 6)

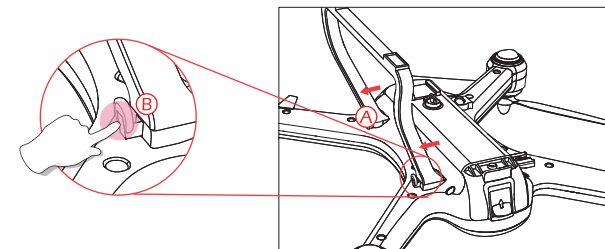

Pic 7

③ Press the buckle on the side of the landing gear to remove it. (Pic 7)

5.4 Propeller Guard & Dust Cover

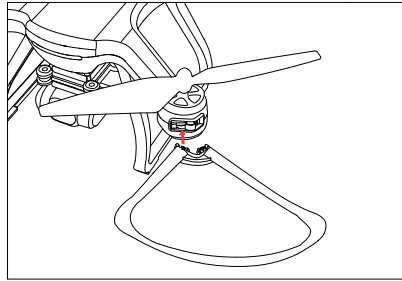

First buckle one side of the Propeller Guard into the groove on the motor base, then buckle the other side, ensuring that the Propeller Guard has been clamped in the groove.

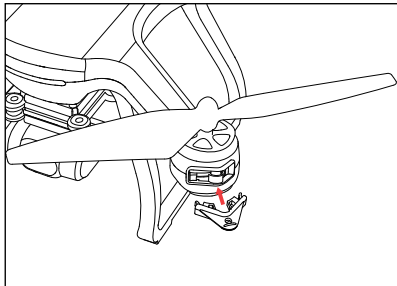

If you do not need to install the Propeller Guard, please install the Dust Cover in the four motor base grooves to prevent dust from entering the drone interior.

5.5 Propellers

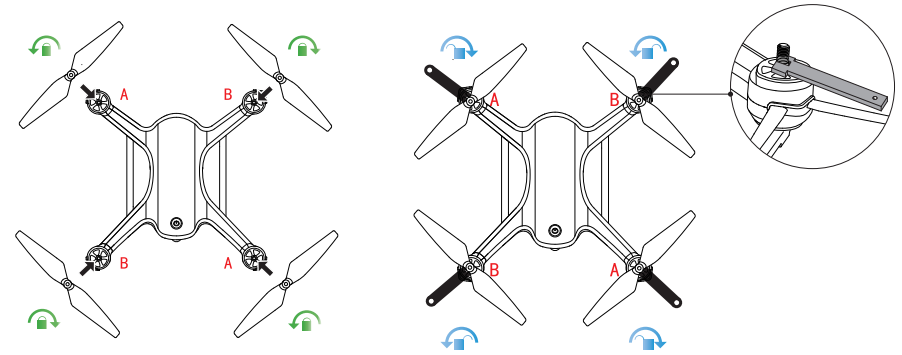

Pic 8

Pic 9

- ① **Installation:** Connect each propeller to its corresponding motor shaft, either position "A/B", then rotate it to tighten the propeller as shown on the "🔒" icon on the propeller. (Pic 8)
- ② **Removal:** Hold the motor with propeller spanner tool and rotate it as shown with the "🔓" icon on the propeller to remove. (Pic 9)

6.0 DRONE'S DETAILS

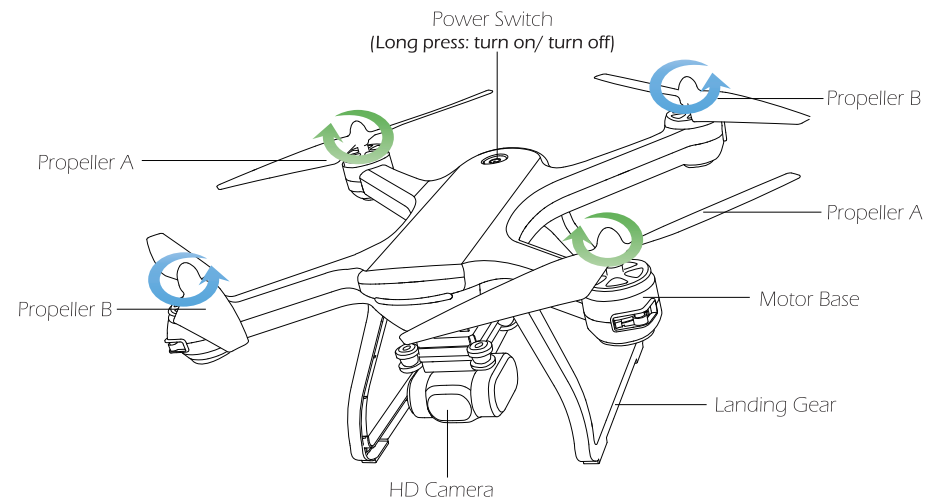

7.0 TRANSMITTER DETAILS

7.1 Transmitter Functions

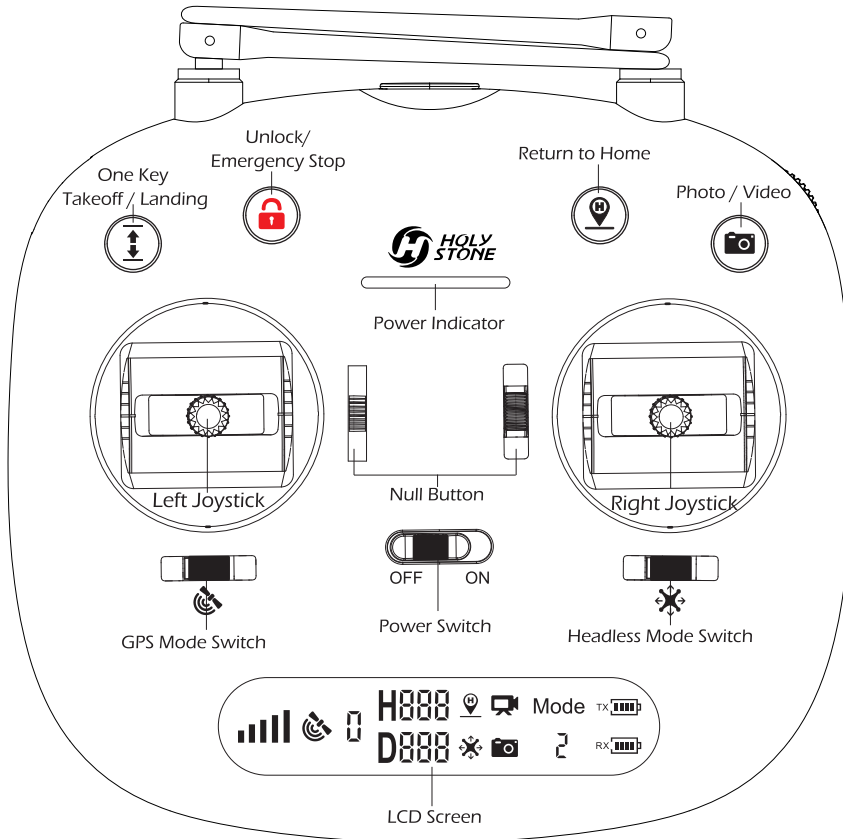

One Key Take off / Landing: One button take off, one button landing.

Unlock / Emergency Stop:

Press “🔒”, to make the motors rotate, unlocking the drone.

Hold the button 3 seconds for activate Emergency Stop.

Return to Home: The Return to Home function brings the drone back to the last recorded Home Point.

Photo / Video:

Click “📷” to take a photo or hold the button for 2 seconds to take the video.

GPS Mode Switch:

When turning on the transmitter, the default mode is the GPS Mode. You can turn off GPS by sliding the switch. Check the icon “📶” on the LCD screen to confirm whether the GPS is on or off.

Headless Mode Switch:

When turning on the transmitter, the default mode is Non-headless mode. You can turn on Headless Mode by sliding the switch. Check the icon “🌀” on the LCD screen to confirm whether Headless Mode is on or off.

7.2 LCD Screen Functions

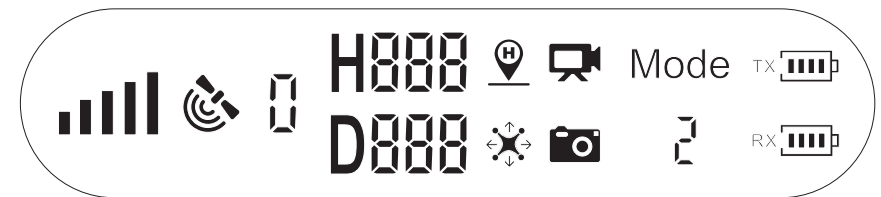

	Signal Strength		Headless Mode
	GPS Mode		Video
	Satellites Connected		Photo
	Altitude (Meter)		Transmitter Throttle Mode
	Distance(Meter)		Transmitter Battery Level
	One Key Return		Drone Battery Level

7.3 Mode Switch

7.3.1 MODE 2 (Left hand throttle MODE 2 is the default setting.)

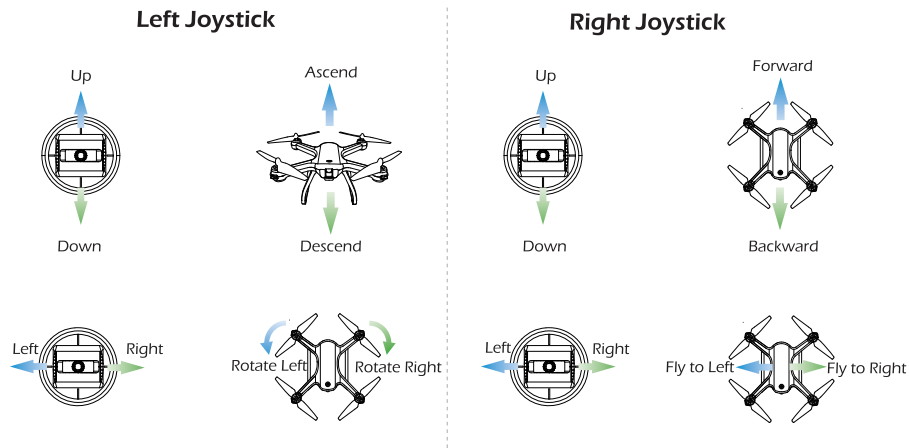

7.3.2 MODE 1

- ① Hold down the “” and then turn on the power switch.
- ② Press the “” button for 3 seconds to enter MODE 1.

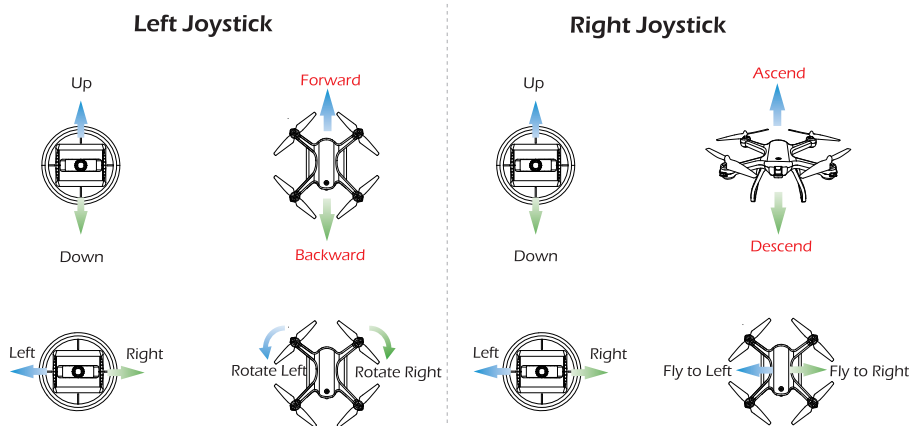

8.0 CHARGING

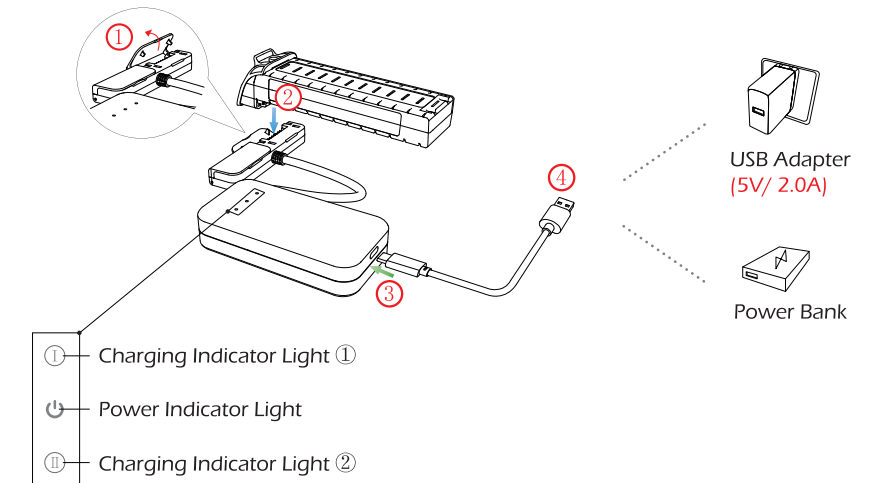

- ① Connect the Battery, Battery Charger Hub and USB Charging Cable.
- ② Connect the USB Charging Cable to a Power Bank or a USB Adapter (5V/ 2.0A) for charging.
- ③ While the battery is charging, the charging indicator on the battery will flash green quickly and the power indicator will show a red light.
- ④ When the battery is full charged, both the green and red lights will turn solid.
- ⑤ The charging time of a single battery is about 5~7 hours.



- Before charging, please check the contents of the “ **Use of Battery**” section of the “ **Safety Guidelines**” carefully!
- This product **ONLY** includes a single battery, however you can choose to purchase another battery to extend your flight time.
- When two batteries are being charged at the same time, the indicator light of the battery currently being charged flashes green quickly while the indicator light of the battery waiting to be charged flashes green slowly.

9.0 OPERATION GUIDE

All of the operations shown in this manual are demonstrated using MODE 2

9.1 Download APP



iOS



Android APP on Google play

Scan the QR code, corresponding to either the App Store™ or Google Play™ Store and download the “**Ophelia GO**” application for free.

9.2 Transmitter's Battery

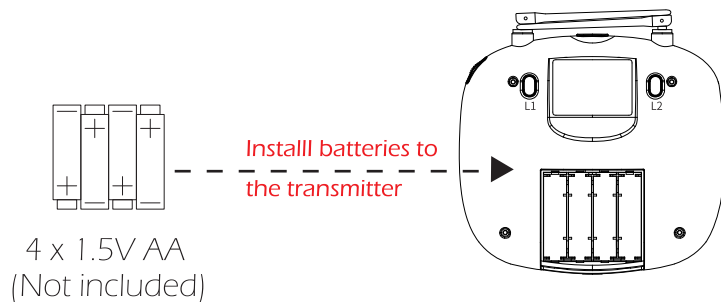

! If you want to install the batteries, please always pay close attention to battery polarity to make sure they are inserted correctly.

9.3 Drone's Battery

Installation:

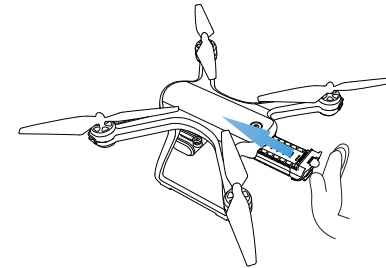

Push the battery into the battery compartment, and make sure that the battery is firmly installed.

Battery Removal:

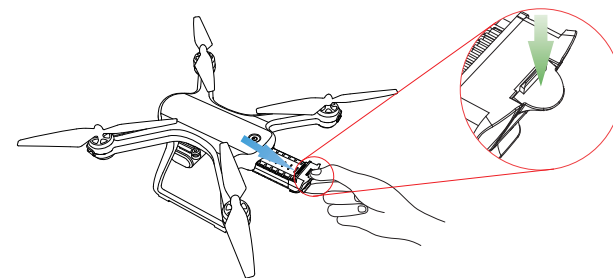

Press the buckle on the back of the battery while pulling backwards to remove the battery.

9.4 Pairing

① Long press the Power Switch to turn on the drone then place it on a level surface with the head forward.
(Long press again to turn off the drone.)

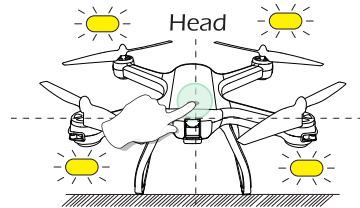

② Hold the "🔒" button and slide the power switch to the right to power on the transmitter.

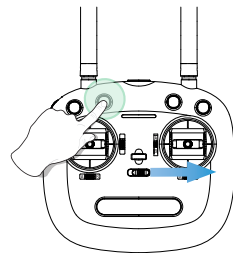

③ The "📶" icon on the transmitter LCD screen will light up when the drone has been paired successfully.

9.5 Initialization Detection

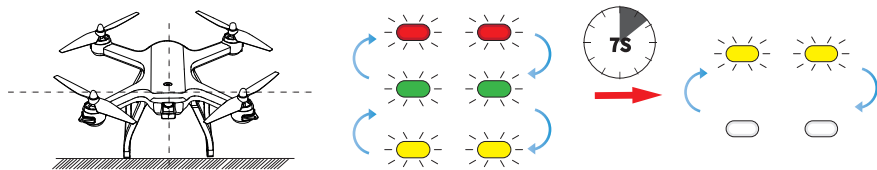

Place the drone on the level surface and it will enter the "Initialization Detection". The red, green and yellow LED lights of the drone will alternate flickering for about **7 seconds** to complete the initial detection. When completed the front and back yellow lights will flicker.

(If the transmitter is not turned on after the drone is turned on, the indicator light will turn yellow and flicker.)

9.6 Calibrating the Compass

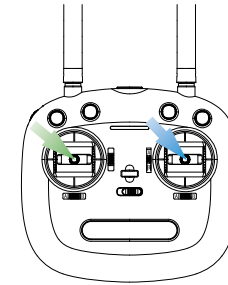

Step 1: As shown in the figure above, push both of the joysticks down to the bottom right at the same time to enter the compass calibration.

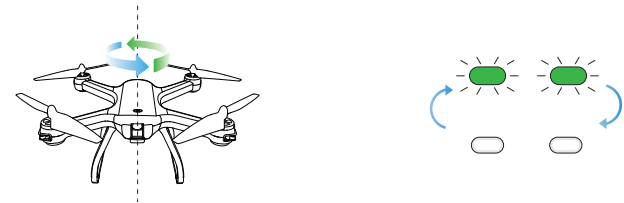

Step 2: Hold the drone horizontally and rotate the drone in 3 complete circles. When completed the green LED lights will flash.



Step 3: Hold the drone vertically and rotate the drone in 3 complete circles. When completed the front red lights and rear yellow lights will turn solid.

9.7 Using the Application

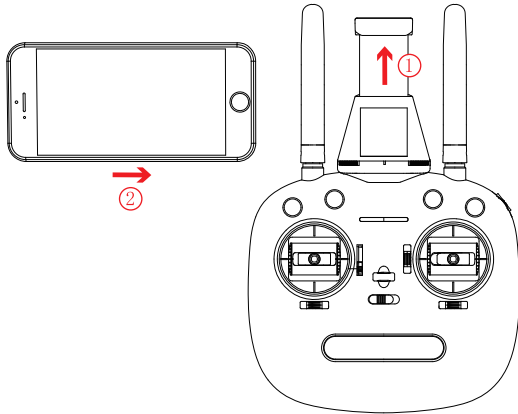

(Pull up the phone holder and insert the phone.)

Connect your smart phone to the Wi-Fi network created by the drone. Check the drone's status in the "Ophelia GO" App.

- ① Your smartphone will launch a search of the available Wi-Fi networks:
- ② Select the Wi-Fi network: **HolyStoneFPV-*******.
- ③ Wait for several seconds until your smartphone connects to the Wi-Fi network of the drone.

This connection is generally represented by the Wi-Fi logo appearing on your smartphone's screen.

- ④ Launch the **Ophelia GO** application.

> The connection between your smartphone and the drone will be established automatically.

9.8 Unlocking

9.8.1 Unlocking the drone:

After the Compass calibration completes, you can unlock the drone to fly it.



Pic 12

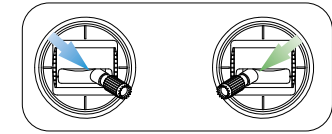

Pic 13

Method 1: Press the Unlock button (Pic 12). The motors rotate and the drone unlocks.

Method 2: Push the left stick to lower right corner and the right stick to the lower left corner at the same time (Pic 13) to unlock the drone.

! Tips:

After unlocking the drone, the motors will automatically stop rotating if you do not take off within 10 seconds.

9.8.2 Locking the drone:

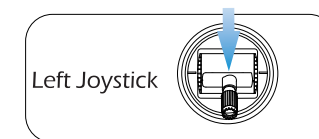

After landing the drone on the ground, pull down on the throttle stick to the bottom position and hold it for 3 seconds. This will make the motor will stop immediately. The drone is now locked.

9.9 One Key Takeoff/ Landing

- ① After unlocking the drone, press the One Key Takeoff/ Landing button and the drone will automatically take off and hover at about 7~11 feet.
- ② While the drone is flying, pressing the One Key Takeoff/ Landing button again will make the drone automatically land on the ground.

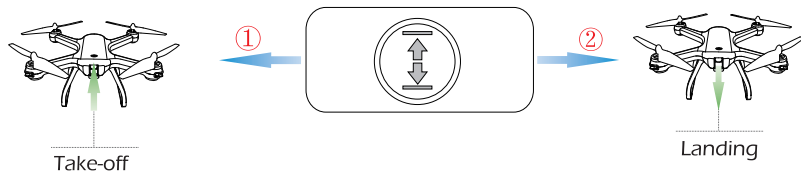

Tips:

Before flying, make sure the GPS Mode is turned on in case the drone gets lost!

9.10 Flight Control

Control the flight by using joysticks.

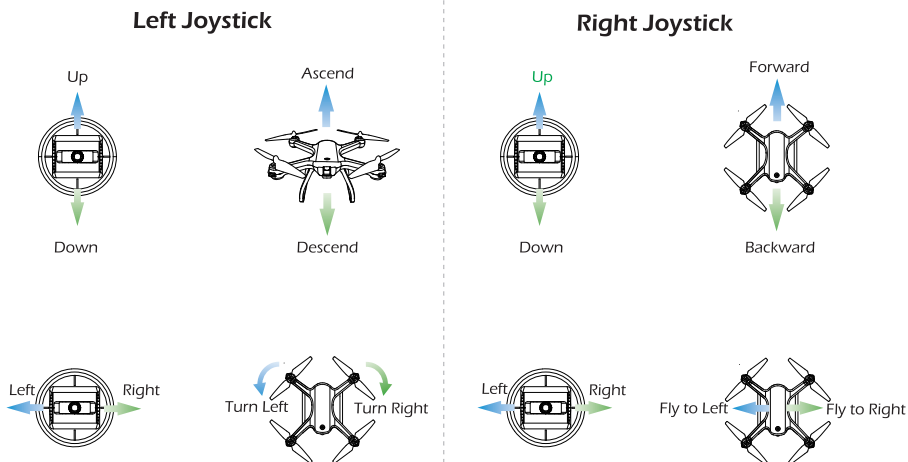

10.0 FUNCTIONS DETAILS

10.1 Transmitter Calibration

- Transmitter calibration is completed by default. It is not necessary to calibrate the joysticks unless pilot feels any abnormal stick travel.
- Please do not power on your drone while your transmitter is under calibration.

- ① Simultaneously hold the “” button and slide the power switch to the right. (Pic 14)

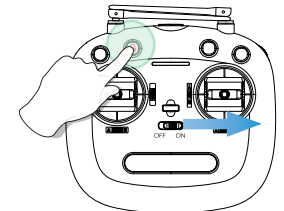

Pic 14

- ② Press “” for 3 seconds and the transmitter will emit 3 beeps. (Pic 15)

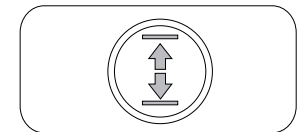

Pic 15

- ③ Rotate both the left and right joysticks in a full circle twice. (Pic 16)

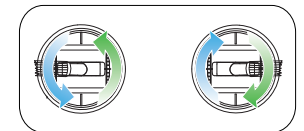

Pic 16

- ④ Press “” for 3 seconds and the transmitter will emit 3 beeps. Transmitter calibration is now completed. (Pic 17)

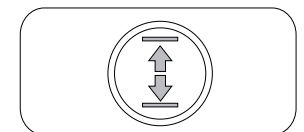

Pic 17

10.2 Headless Mode

① Slide the Headless Mode switch until the “” icon appears on the LCD screen, which means the drone has entered Headless Mode.

② Slide the Headless Mode switch again until the “” icon on the LCD screen disappears meaning that the drone has exited Headless Mode.

(Headless Mode is turned off by default when the transmitter is turned off and back on.)

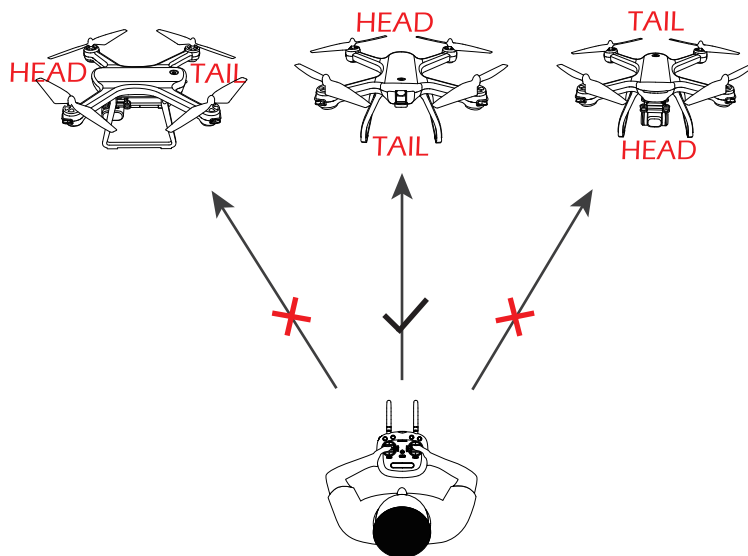

Please make the pilot stays facing the same direction as the direction that the head of the drone faces at take-off.

While in Headless Mode, pushing forward on the joystick will make it fly in the direction that the head of the drone faces at take-off.

To make sure that the pilot can tell drone’s direction, we recommend that pilots stay facing the same direction that the drone head faces at take off.

By doing so it is ensured that when the pilot pushes the direction joystick forward/ backward, the drone will fly forward/ backward toward him/ her. If the pilot move the right stick left/ right, the drone will move left/ right relative to the pilot.

10.3 Return to Home (RTH)

The Return to Home function brings the drone back to the last recorded Home Point.

The Home Point is the location from which the drone first takes off or where the GPS receives a signal from 7 or more satellites for the first time during flight. The current position of the drone will be recorded as the Home Point.

10.3.1 Smart RTH

If the GPS signal is available (at least 7 connected satellites) and the Home Point is recorded previously, press the “” button on the transmitter and the drone will fly back to its Home Point.

Exit the RTH Mode by pressing the “” button again or pushing the Throttle Joystick .

10.3.2 Failsafe RTH

If the GPS signal is available (**At least 7 satellites**) and the Home Point is recorded previously. Failsafe Return will be triggered when the transmitter signal is lost for more than 6 seconds. The drone will automatically start the return procedure which is to fly back to the last recorded Home Point. You can exit “Failsafe RTH” Mode by pressing the “Return to Home” button or pushing the Throttle Joystick if the transmitter signal is recovered.



- During the Failsafe Return procedure the drone can not avoid obstacles.
- The drone cannot Return-to-Home if the GPS signal is weak (connected satellites number is less than 7).
- If there is no GPS signal or the transmitter signal has been lost for more than 6 seconds, the drone will not Return-to-Home but descend slowly until it lands on the ground. Then the drone will lock itself.

10.3.3 Low Voltage RTH

① When rear drone lights flash slowly and the “RX [battery icon]” symbol is displayed on the screen of the transmitter, the First Low Voltage RTH will be triggered. At this point the drone will return automatically with the following two conditions: **The drone can only fly within a safe range of 98 feet high and 328 feet far.**

a. When the flight altitude is higher than 98 feet, the drone will fly back above the Home Point then descend automatically to 98 feet high and exit the First Low Voltage RTH.

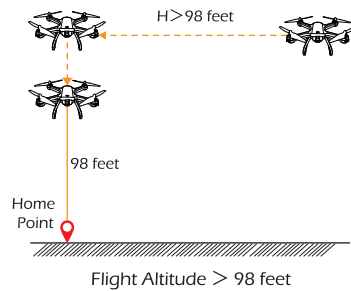

b. When the flight altitude is lower than 98 feet, the drone will elevate automatically to 98 feet high then fly back above the Home Point and exit the First Low Voltage RTH.

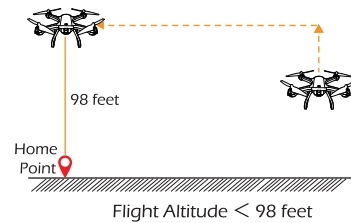

② When the drone's rear lights flash quickly, the “RX [battery icon]” symbol is displayed on the screen of the transmitter, and the transmitter sounds “Di..., Di...”. At this point, the Second Low Voltage RTH will be triggered.

a. When the flight altitude is higher than or equal to 50 feet, the drone will stay at its current altitude and return to above the Home Point then descend vertically.

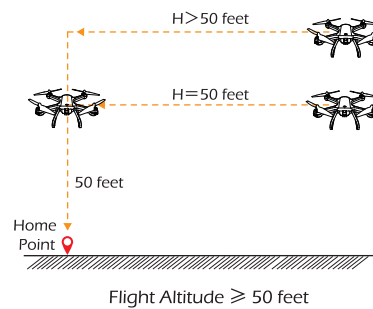

b. When the flight altitude is lower than 50 feet, the drone will automatically elevate to 50 feet then fly back above the Home Point and descend vertically.

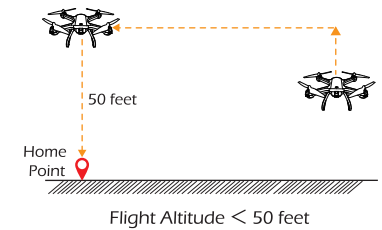

10.4 Camera Angle Adjustment

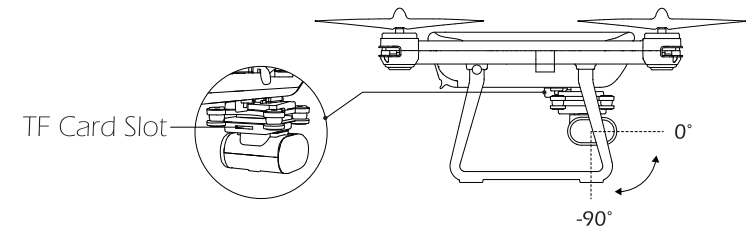

During the flight, you can dial the wheel left / right to tilt the camera up / down.

(The gimbal has an 90° tilt range.)

11.0 DRONE STATUS INDICATOR

Indicator Status	Meanings
	Front and rear lights alternate flashing yellow. The drone is not connected to the transmitter.
	Drone is currently in Initialization Detection status.
	Front light turns solid red, rear light turns solid yellow. No GPS signal or weak GPS signal.
	Front light turns solid red, rear light turns solid green. Good GPS signal.
	Front and rear lights flash green quickly. Currently calibrating the Gyroscope.
	Compass Horizontal Calibration has completed.
	Initialization Detection or gyroscope Calibration has completed.
	Front light turns solid red, rear light flashes red slowly. Entering the First Low Voltage RTH.
	Front light turns solid red, rear light flashes red rapidly. Entering the Second Low Voltage RTH.

12.0 APP OPERATION INSTRUCTION

12.1 Operation Interface

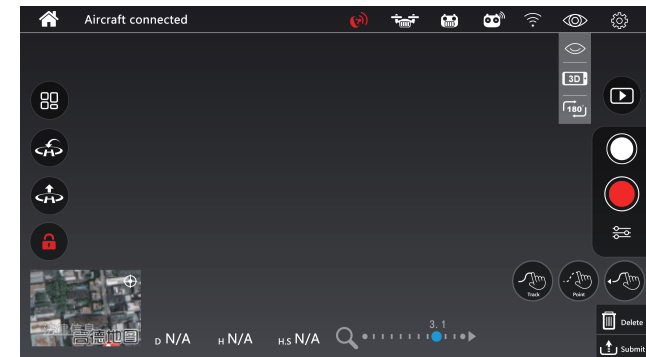

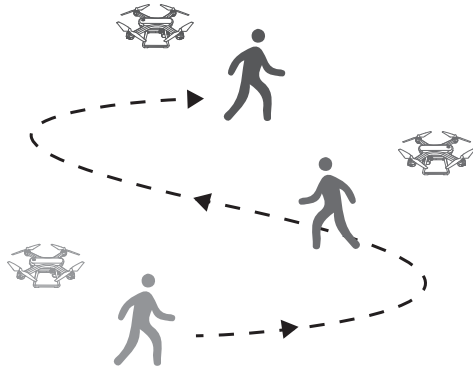

	Homepage		Setting		Take Photo
	GPS Signal		RTH Switch		Record Video
	Drone Battery Level		One Key Take off / Landing		Camera Settings
	Transmitter Battery Level		Unlock		TapFly
	Transmitter Signal Strength		Gallery		Delete
	Signal Strength		Follow-me Switch		Submit
	Hide On/ Off		Point of Interest		Distance (m)
	3D VR		Headless Mode		Height (m)
	180° Screen Rotation				Speed (m/s)

12.2 Follow Me



When the Follow Me function is enabled, the drone will follow the GPS in your smart phone to follow you wherever you go.



1. Ensure the drone's flight range is within 15~95 feet.
2. Click the “” icon first, then select the “” icon, and follow the prompt box to enter the Follow Me function — the drone will now follow the phone's coordinates.
3. To exit Follow Me Mode, simply click the “” icon on the app interface again.

Common Issues :

- The Follow Me function can only be used if the flight range is within 15~95 feet.
- Follow Me mode may be difficult to activate if the phone's GPS signal is too weak. This could be due to the signal loss from surrounding buildings, trees, or congestion from too many mobile phones in the area.
- Use in an open area and be mindful of your surroundings. The drone is NOT equipped with obstacle avoidance.

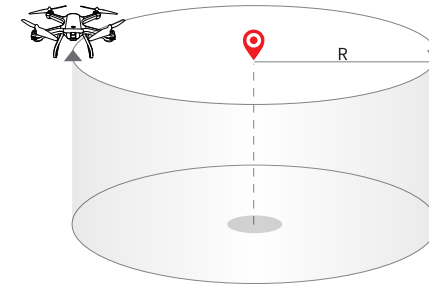
12.3 Point of Interest





1. Click the “” icon first, then select the “” icon, and follow the prompt box to enter the Point of Interest function.
2. The drone will record its flight position the moment you enter this function as the point of interest. The drone will now continuously circle clockwise around the preset point. (The default radius is 16 feet.)
3. To exit Point of Interest mode, simply click the “” icon on the application interface again.

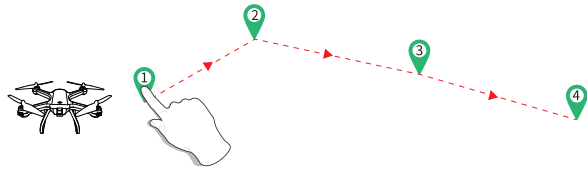

12.4 TapFly

It is recommended to enlarge the map if you want to use TapFly.



1. Please click on the Map first, then click the “” icon, and follow the prompt box to enter the TapFly function.

MODE 1: Click the “” icon on the app interface, draw a line on the screen to create a path, click “” icon to submit the route, and the drone will fly along the path.

MODE 2: Click the “” icon on the app interface, set any point on the screen, click “” icon to submit the route. The drone will now fly along the path according to the points connected on the map.



2. Exit the TapFly mode by clicking the “” icon again.

3. If the flight path submission fails, you can choose to re-submit or exit again.



- DO NOT fly the drone towards people, animals, or small/ fine objects (e.g. tree branches and power lines) or transparent objects (e.g. glass or water).
- There may be some deviation between the expected and actual flight path.

12.5 Take Photo/ Video

1. Click the “” icon to take photo, click once to take a photo.
2. Click the “” icon to record video, click once to start recording, and click again to stop recording.
3. Click the “” icon to enter the gallery for viewing.

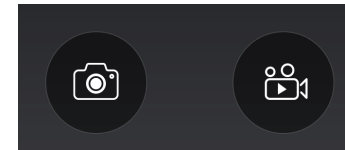

Tips:

The photos and videos stored in the TF card can only be viewed when the drone is turned on.

13.0 SPECIFICATIONS

DRONE

Model: HS700D

Weight: 630g / 22oz

Max Flight Time: 22 minutes (per battery)

Motor Model: 2204 1400KV

Operating Temperature Range: 32° to 104°F

Size: 434 x 434 x 151 mm

TRANSMITTER

Operating Frequency: 2.4 GHz

Transmitter Power (EIRP): <16 dBm

Max Flight Distance: 3277 feet / 999m (outdoor and unobstructed)

Battery Type: 4×1.5V AA batteries (Not included)

Operating Temperature Range: 32° to 104°F

DRONE BATTERY

Capacity: 2800 mAh

Voltage: 7.4 V

Battery Type: Li-Po

Energy: 20.72 Wh

Charging power: 5~10 W

Charging Temperature Range: 41° to 104°F (5° to 40°C)

Charging Time: 5~7 Hour

CAMERA

Operating Frequency: 5 GHz

Video/ Photo Resolution: 3840×2160P (stored in TF card)

1920×1080P (stored on mobile phone)

Lens: FOV 120°

Max Transmission Distance: 984~1640 feet /300~500m (outdoor and unobstructed)

Transmission Frame Rate: 16 fps

Photo Formats: JPEG

Video Formats: AVI / MP4

Supported TF Cards: Supports a TF Card with capacity of up to 32 GB (Not included)

Controllable Range: Pitch: -90° to 0°

Operating Temperature Range: 32° to 104°F

USB CHARGING CABLE

Voltage: 5 V

Rated Power: ≤10 W

14.0 TROUBLE SHOOTING

No.	Problem	Solution
1	When the drone is powered on, the indicator light keeps flashing rapidly.	The drone is in the gyroscope calibration state. Please place the drone on an flat and level surface.
2	The drone cannot hover after takeoff and tilts to one side.	Place the drone on a flat, level surface and repeat the gyro calibration.
3	The drone vibrated in flight.	The propeller are damaged. Please replace the new propeller.
4	The drone could not be unlocked and the rear light flashed.	The drone battery voltage is too low. Please fully charge the battery.

15.0 CONTACT US

Please do not hesitate to contact us if you need further support.

✉ usa@holystone.com (America)
ca@holystone.com (Canada)
eu@holystone.com (Europe)

☎ +1(855) 888-6699

16.0 GENERAL INFORMATION

FCC Notice:

This device complies with Part 15 of the FCC Rules.

Operation is subject to the following two conditions:

- (1) This device may not cause harmful interference.
- (2) This device must accept any interference received, including interference that may cause undesired operation.

NOTE: This equipment has been tested and found to comply with the limits for a Class B digital device, pursuant to Part 15 of the FCC Rules. These limits are designed to provide reasonable protection against harmful interference in a residential installation. This equipment generates uses and can radiate radio frequency energy and, if not installed and used in accordance with the instructions, may cause harmful interference to radio communications. However, there is no guarantee that interference will not occur in a particular installation. If this equipment does cause harmful interference to radio or television reception, which can be determined by turning the equipment off and on, the user is encouraged to try to correct the interference by one or more of the following measures:

- Reorient or relocate the receiving antenna.
- Increase the separation between the equipment and receiver.
- Connect the equipment into an outlet on a circuit different from that to which the receiver is connected.
- Consult the dealer or an experienced radio/TV technician for help.

WARNING: Changes or modifications not expressly approved by the party responsible for compliance could void the user's authority to operate the equipment.

RF Exposure

The equipment complies with FCC radiation exposure limits set forth for an uncontrolled environment. This device should be installed and operated with minimum distance 20cm between the radiator & your body.

IC Notice:

This device complies with Canada Industry licence-exempt RSS standard(s). Operation is subject to the following two conditions:

- (1) this device may not cause interference; and
- (2) this device must accept any interference. Including interference that may cause undesired operation of the device.

CAN ICES-3 (B)

Avis d'Industrie Canada

Le présent appareil est conforme aux CNR d'industrie Canada applicables aux appareils radio exempts de licence L'exploitation est autorisée aux deux conditions suivantes:

- 1) l'appareil ne doit pas produire de brouillage; et
- 2) l'utilisateur de l'appareil doit accepter brouillage radioélectrique subi même si le brouillage est susceptible d'en compromettre le fonctionnement. mauvais fonctionnement de l'appareil. Cet appareil numérique de la classe B est conforme à la norme NMB-003 du Canada.

CAN NMB-3 (B)

RF Exposure

Radiation Exposure Statement:

This equipment complies with IC radiation exposure limits set forth for an uncontrolled environment. This equipment should be installed and operated with minimum distance 20cm between the radiator & your body.

Déclaration d'exposition aux radiations:

Cet équipement est conforme aux limites d'exposition aux rayonnements

IC établies pour un environnement non contrôlé. Cet équipement doit être installé et utilisé avec un minimum de 20 cm de distance entre la source de rayonnement et votre corps.

HOW TO RECYCLE THIS PRODUCT

This symbol on the product or its documentation indicates that it must not be disposed of with household waste.

Uncontrolled waste disposal may harm the environment or human health. Please separate your device from other types of waste to recycle it responsibly.

This will help to foster the sustainable re-use of material resources.

We invite you to contact your retailer or inquire at your local town hall to find out where and how the drone can be recycled.



BATTERY WARNING:

1. Failure to follow all the instructions may result in serious injury, irreparable damage to the battery and may cause a fire, smoke or explosion.
2. Always check the battery's condition before charging or using it.
3. Replace the battery if it has been dropped, or in case of odor, overheating, discolouration, deformation or leakage.
4. Never use anything other than the approval LiPo charger the battery. Always use a balancing charger for LiPo cells or a LiPo cell balancer. It is recommended that you do not to use any other charger than the one provided with the product.
5. The battery temperature must never exceed 60°C (140°F) otherwise the battery could be damaged or ignite.
6. Never charger on a flammable surface, near flammable products or inside a vehicle (preferably place the battery in a non-flammable and nonconductive container).
7. Never leave the battery unattended during the charging process. Never disassemble or modify the housing's wiring, or puncture the cells. Always ensure that the charger output voltage corresponds to the voltage of the battery. Do not short circuit the batteries.
8. Never expose the LiPo battery to moisture or direct sunlight, or store it in a place where temperatures could exceed 60°C(car in the sun, for example).
9. Always keep it out of reach of children.
10. Improper battery use may result in a fire, explosion or other hazard.
11. Non-rechargeable batteries are not to be recharged. Rechargeable batteries are only to be charged under adult supervision.
12. Different types of batteries or new and used batteries are not to be mixed.

13. Batteries are to be inserted with the correct polarity.
14. The supply terminals are not to be short-circuited. Regular examination of transformer or battery charger for any damage to their cord, plug, enclosure and other parts and they must not be used until the damage has been repaired.
15. The packaging has to be kept since it contains important information.
16. The toy is only to be connected to Class II equipment bearing the symbol. 

EU RF Power(EIRP): <16 dBm (2413MHz ~ 2461 MHz)

Caution

1. The max operating of the EUT is 45°C. and shouldn't be lower than -10°C.
2. The device complies with RF specifications when the device used at 0mm from your body.
3. Declaration of Conformity.

We, Xiamen Huoshiquan Import & Export CO.,LTD hereby, declare that the essential requirements compliance with the Directive 2014/53/EU, the RoHS Directive 2011/65/EU and Safety Directive 2009/48/EC have been fully fulfilled on our product with indication below:

Product Name: REMOTE CONTROL MODEL/RADIO CONTROLLED
Model/Mark : HS700D/HOLYSTONE

The Statement of compliance is available at the following address:
http://www.holystone.com/Download/CE/HS700D_EU_DOC.pdf
This product can be used across EU member states.

MANUFACTURER INFORMATION

Manufactured by
Xiamen Huoshiquan Import & Export CO.,LTD
Room 703, No. 813-2 Xiahe Road, Siming District, XIAMEN, China
+1 (855) 888-6699



FAA REGISTRATION: PLEASE FOLLOW ALL FEDERAL, STATE AND LOCAL FAA LAWS. YOU MAY BE REQUIRED TO REGISTER YOURSELF AND YOUR DRONE WITH THE FAA MORE INFO CAN BE FOUND AT: [HTTPS://WWW.FAA.GOV/UAS/GETTING STARTED/](https://www.faa.gov/uas/getting-started/)

After receiving the certificate of registration, you must mark your **unique FAA registration number** on the Drone by any means, such as permanent marker, label, engraving. This number must be readily accessible and maintained in a condition that is readable and legible upon close visual inspection

WARNING: Do **NOT** fly drone near airports or any other un-authorized areas. Follow all rules for Federal Aviation Administration (FAA) regulation summary for Small Unmanned Aircraft Systems (sUAS).
Read: Academy of Model Aeronautics (AMA) Know Before You Fly important information brochure.



Made in China