



SKT Email

  
**kochstar**  
Made in Germany

## PRESSURE COOKER Instruction Manual



 Quality  
 Made in  
 Germany

# Contents

1	Important safeguards	page 03-04
2	Quick start	page 05-06
3	Pressure cooking	page 07-10
4	Notes of safety	page 11-13
5	Operating instructions	page 14-16
6	Cleaning and maintenance	page 17
7	End of cooking time	page 18
8	Questions and Answers	page 19
9	Food preparation instructions	page 20
10	Cooking times / tips	page 21-22

 Quality  
Made in  
Germany



nominal fill	capacity max. 2/3	pot dia.
6.0 l	4.0 l	22 cm
4.5 l	3.0 l	22 cm
3.0 l	2.0 l	22 cm

We are delighted that you have selected our quality product. Before using your new pressure cooker, please read these instructions for use carefully and completely.

Please note that improper use may possibly lead to damages. Before first use, read these instructions and keep them stored for future reference!

1. People not familiar with the use of this pressure cooker should not be allowed to use it.
2. Never leave the pressure cooker unattended while under pressure.
3. If you use this pressure cooker when children are in the vicinity, please be particularly careful.
4. Use this pressure cooker only for the purpose of fast cooking, for which it was designed.
5. On each occasion before use, check the cleanliness and function of the safety valve and pressure-regulation valve, as well as the sealing ring.
6. Pressure will build up during the cooking process. It is important to close the lid tight before using the cooker and to carefully read the notes on use and safety in the Instructions for Use because wrong use may lead to personal injuries or damages to the cooker.
7. This pressure cooker is provided with a pressure indicator. Movement of pressure indicator indica.
8. Never exceed the specified minimum fill capacity  
(= liquid + cooked food)
9. Never exceed the specified maximum fill capacity.  
(= liquid + cooked food)
10. Only use the pressure cooker on heat sources that are specified in the Instructions for Use.
11. Under pressure, the pressure cooker must never be used for roasting or frying oil.

- 
12. Never use the pressure cooker in a baking oven as it may be damaged.
  13. See the extra notes on preparing special foods in the Instructions for Use described in the Safety Notes section.
  14. Always touch the hot pressure cooker by its handles.
  15. Never force open the pressure cooker. Before opening the pressure cooker, make sure that the pressure has been completely relieved. (See further formation in the Instructions for use).
  16. When releasing the steam, keep hands, head, and body out of the way of the steam.
  17. The pressure cooker's lid and other parts are not dishwasher safe.
  18. Exclusively use original spare parts.
  19. If repairs are necessary, please contact our customer service department.  
(see front cover for contact information).
  20. Never use scouring agents or wire wool for cleaning.
  21. Pot must not be used for deep-frying oil, fat, or grease.
  22. Do not leave oil or grease unattended. Please be aware that hot oil or grease can catch fire. Never use water to extinguish a grease fire. Cover with a lid or other appropriate cover or use fire extinguisher.



## 1.) Open

Release the lid-lock. Draw the lid and cooker handles apart. Remove the lid



## 2.) Closing

The circle symbols on the lid and the cooker handle should be opposite one another. Push the lid and cooker handles together. The cooker lid is locked.

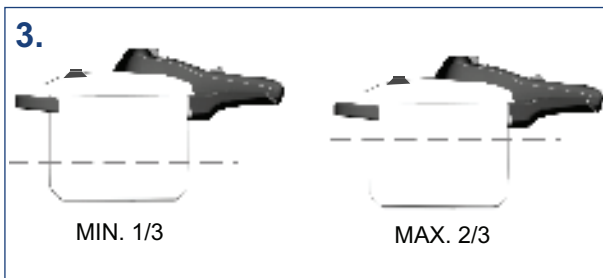

## 3.) Fill with the food to be cooked

Take care to observe the minimum liquid level of approx. 250 ml. (see page 12-14). Now add the food to be cooked. Maximum 1/2 full for foods which swell up or foam. Maximum 2/3 full for all other foods.



4.) Set pressure level



5.) Turn the heating element up to full



6.) Pressure cooking starts

When steam escapes, turn the heating element down to the lowest setting



7.) Cooking time finished  
Switch off the stove.



8.) Release the pressure slowly in stages.  
Or, depending on the recipe, wait until the pressure has subsided. Caution - the steam will be extremely hot! (see page 16)



9.) Open the pressure cooker (see page 16)

To guarantee both its safety and long service, this pressure cooker is manufactured to extremely high standards, and only the best materials are used. We hope you will obtain plenty of enjoyment from its use.

This pressure cooker offers you many advantages:

- Adjustable pressure-regulation valve.
- Instructions in recipes and cooking time tables should only be guidelines. This is why we have developed an adjustable pressure-regulation valve which you can set in two positions between 1 and 2. This has the advantage that, according to size or amount of the food to be cooked, you can set the pressure individually in the cooker using the valve. Please consult the cooking times table at the end of this instruction booklet for basic settings.
- You will cook more healthier.
- Your food will be prepared especially gently by cooking it for a shorter time and in the oxygen-free steam. Every minute you save means a saving of important vitamins, nutrients and minerals.
- Your cooking will taste better. By cooking without oxygen, the flavor and natural coloring of your vegetables will be preserved.
- You will cook more quickly and save time and energy
- Using this pressure cooker you will save up to 70% of the time you have previously spent on cooking.
- To a large extent, cooking smells and cooking vapors will now disappear. If you look after your pressure cooker well, you will enjoy your pressure cooker for a long time.

Please read these Instructions for Use carefully and completely.



electric

gas

ceramic

induction

Fits all oven types.



- 1 Pressure regulator valve
- 2 Safety valve
- 3 Pressure indicator
- 4 Sliding locking-catch
- 5 Safety window

- 6 Locking markings
- 7 Lid with sealing ring
- 8 Handle with flame protection
- 9 Cooker pot
- 10 Thermo sandwich bottom



The pressure regulator valve is used for variable cooking settings. The valve keeps the pressure and temperature at the desired setting automatically.

Position **1** for gradual cooking (60 kPa) approx. 113°C

Position **2** for quick cooking (100 kPa) approx. 120°C

Position  for gradual release of pressure

Position  for cleaning the valve

Maximum permitted pressure for this pressure cooker: 3.0 bar / 300 kPa





The safety valve:  
While pressure in the cooker is building up, the RED pressure indicator is visible and the cooker is locked (never attempt to open it using force).



If the pressure indicator is not visible, the cooker is no longer under pressure. It can then be opened.

If for any unexpected reason the pressure regulator valve does not release steam as it should, this valve will open in accordance with the prescribed values.



1. green ring visible (1 = Gradual cooking)

Tips in recipes and cooking times can only offer guidance. Therefore, we have developed a pressure valve, which you can set between positions 1 and 2. This has the advantage that you can use the valve to adjust the pressure inside the pot individually according to the amount and size of the food to be cooked.

Please refer to the basic settings, which can be found in the cooking timetable at the end of these instructions.



2. green ring visible (2 = Fast cooking)

Thanks to the oxygen-free cooking in steam and the shorter cooking times, your food is prepared especially gently. This means you cook healthier. Every minute you save cooking, means you gain important vitamins, nutrients and minerals.

Cook with more flavor.

Thanks to the oxygen-free cooking, the aroma and the natural colors of your vegetables are mostly preserved.



3. red ring (excess pressure)

Cooking with this pressure cooker saves you up to 70% of your time compared to conventional cooking methods. And you save 60% energy with long-cooking meals, versus between 30% and 40% when preparing meals with a short cooking time.

You cook with minimal cooking odors and steam.

When well maintained, you will enjoy using your pressure cooker for a long time.



The sliding locking-catch:

When the lid is closed, the sliding locking-catch clicks audibly into place. The lid can then only be unlocked by pressing the locking-catch in the direction of the cooker body.



The safety window:

An additional safety element is the safety window in the top of the lid. If there is excessive pressure in the cooker, the sealing ring forces its way out through this window, and the steam can escape.



The locking system:

Place the lid on the cooker so that the locking markings are opposite each other and slide lid and cooker handles one above the other. The sliding locking-catch clicks audibly into place. A pressure cooker generates very high pressure and steam temperature. Please be certain to observe the instructions on pages 8 and 10 of these instructions for use under the subject opening.



The lid and sealing ring:

Sealing rings are subject to wear-and-tear, and must be replaced when necessary. Important: you should only use our own original sealing rings that were included in the box at the time of purchase.



Traditional enamel bayonet pressure cooker RUBIN with ceramic coating  
KERAMICO® "MADE IN GERMANY"

The pressure cooker with high quality KERAMICO® coating and "Made in Germany" is easy to clean and -without lid – dishwasher safe.

KERAMICO® coating has various advantages:

- scratch proof, nickel-free and poreless surface
- hygienic and easy to clean
- neutral in taste, non toxic and physiological harmless
- available in various colors
- efficient for induction

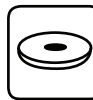

electric



gas

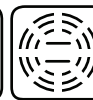

ceramic

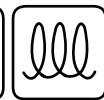

induction

Fits all oven types.

Quality  
Made in  
Germany

Before first using the pressure cooker, please read these instructions.

The pressure cooker and pressure cooker lid should be cleaned thoroughly using hot water on each occasion before use.

If after the first boiling, white spots should form on the bottom of the pot, these are caused by extreme hardness of the water.

These spots can easily be removed either using vinegar or descaler. On no account should you use abrasive cleaners or wire wool for cleaning. This also applies for cleaning the stainless steel exterior.

Please check that the pressure-regulation valve and the safety pin are freely moveable.

People not familiar with the use of this pressure cooker should not be allowed to use it.

If you use this pressure cooker when children are in the vicinity, please be particularly careful.

This pressure cooker may only be used for the purpose of fast cooking, for which it was designed. It may only be used as a normal saucepan without a lid. Please never use it in a baking oven or in a microwave.

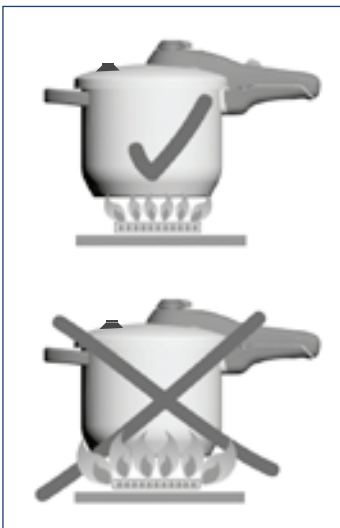

The pressure cooker may only be placed on the appropriate stove grate for its size. When using full power to heat it, always keep it under observation.

When using it on the an electric stove top, the hotplate must be less than or equal to the diameter of the pot.

When using it on a gas stove, the flame ring must not exceed the base diameter.

A gas flame that is too large may damage the handles.

When using it on a ceramic stove top, make sure the bottom of the pot is clean and dry.

Never touch the outside of the pressure cooker during the cooking procedure, as you may burn yourself.

---

If the pressure cooker is still hot, it must only be touched or moved with great care, and by using the handles on the pressure cooker itself; not the handle on the lid.

Do not carry the pressure cooker by holding it on the lid's bow. Always use both hands to carry it by holding the side handles.

Continuously check the tightness of the pressure cooker handles. Once you observe handles become loose, use a screwdriver to fasten them properly again.

The pressure cooker must never be used without liquid, otherwise it may be damaged.

The minimum amount of liquid should be approximately 250 ml. irrespective of the amount of the food to be cooked.



The pressure cooker should be filled at least 1/3 full including the food to be cooked.

The pressure cooker must never be filled more than 2/3 full, or when cooking food which wells up or bubbles strongly (e.g. rice or pasta) not more than half full. These foods should first be brought to boiling in the uncovered pressure cooker and then skimmed before the lid is closed.

Under pressure, the pressure cooker must never be used for roasting or frying oil.

When preparing sausages with an artificial skin, this must first be pierced. If the skin is not pierced, it will expand under pressure and may burst. Any splashes may cause burns.

If you have cooked meat with the skin on which is swollen after cooking, do not pierce it but let it go down. Otherwise you might burn yourself.

You should not pressure-cook foods which tend to cause foaming, such as apple purée, rhubarb, spaghetti, rolled oats or other types of cereals. These foods can be swirled upwards during cooking and there is a risk of the cooker valve becoming blocked.

If the contents are mushy, the pressure cooker must be agitated gently before opening it.

During cooking, bursts of steam will be given off vertically from the center of the regulator valve.

Please be careful that you do not come into contact with this hot steam.

During the cooking process, the safety devices must not be interfered with.

When the pressure cooker is under pressure, force must never be used in an attempt to open it.

The pressure cooker must be allowed to cool down before it is opened. Steam pressure must be completely released, otherwise it will not be possible to open the cooker. Please read the opening instructions (page 16).

Do not undertake any modifications to the safety devices; otherwise there is risk of scalding. When releasing the steam, keep hands, head and body out of the way of the steam.

You should only use original accessories and spare parts or lids and pots as designed for these pressure cookers.

Pressure cookers or accessories which are deformed or damaged in any way should not be used in any circumstances.

If repairs are necessary, please contact our customer service department.

Before each use, make sure that the safety locking system, the pressure regulator and the sealing ring are all clean and functioning properly.

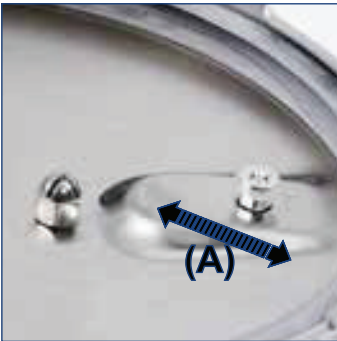

Particularly ensure that the safety valve on the underside of the lid (A) can be moved.



The pin (B) should be checked for free motion (against spring pressure) using a pointed object.



Fill the pot with sufficient liquid to generate the necessary steam (water, sauce or stock).

**WARNING:** always add adequate liquid. NEVER let the pressure cooker "cook dry".  
Now add the cooking material.

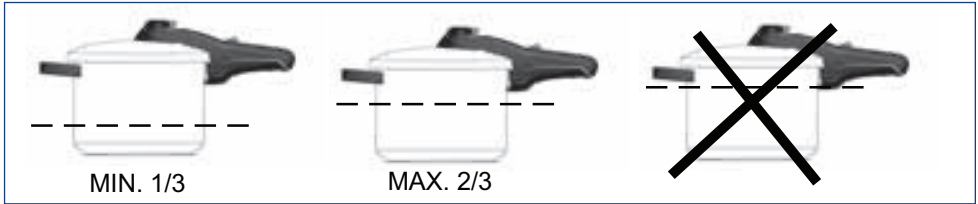

Liquid and food to be cooked should fill at least 1/3 of the pot's capacity.

Maximum 1/2 full for foods that expand or tend to foam.  
Maximum 2/3 full for all other foods.



Please observe the filler scale inside the pot.  
Please check that there is adequate space between the food to be cooked and the lid with safety valves.

**Note:**  
You should only add salt to water which is already boiling, and stir it gently so that the base of the pot doesn't get corroded.

Now put the lid on the cooker.  
One-hand opening / closing system with push button



Setting the desired cooking level:  
Position 1 :

Gradual cooking stage for steaming and stewing more delicate foods such as vegetables, fish and fruit.



1. green ring visible (1 = Gradual cooking)



Position 2 :

Fast cooking stage for cooking and braising e.g. meat, soups and stews.



2. green ring visible (2 = Fast cooking)

Cooking time table Page 21 – 22



Pressure cooking is so easy...

Select the desired cooking level with the help of the pressure-regulation valve:

Set pressure stage

1 = Gradual cooking (1. green ring visible)

2 = Fast cooking (2. green ring visible)



Set oven to top cooking level

Place the pressure cooker with preset cooking setting on the correct source of heat, and turn it up to full power.



The red pin will become visible with increasing pressure. From this point on, the pot must not be opened



Depending on how full the cooker is, it will take several minutes until the preset cooking stage has been reached. This is the case as soon as steam starts to escape continuously from the pressure-regulation valve.

The actual cooking time only starts from this moment. Only at this point should the source of heat be turned down to a lower stage.

In this way, you avoid unnecessary consumption of energy and the risk of the cooker boiling dry.

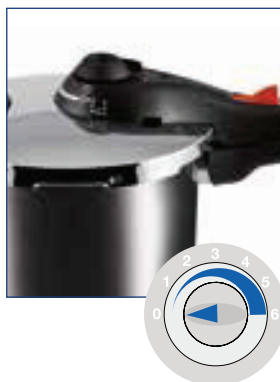

At the end of the cooking time. Switch off oven.



Gradually steam off, or wait until the pressure is relieved.

Do not turn from position 1 or 2 to 0. But, gradually set valve to position 0.

Warning: The escaping steam is extremely hot (see pages 12-13).

Opening the pot  
Wait until all steam has escaped, at which point you can switch off the pressure cooker. The lid may be removed.



**WARNING:** Never use force to open the lid.



When cooking time has finished, turn the heating source off to release the pressure in the cooker. Take the cooker away from the stovetop, and place it on a suitable surface. There are the following 2 options for releasing the pressure:

1.) Let it cool down:

Wait until the red pin on the safety valve has completely disappeared. This is the recommended method for foods which are mushy or tend to foam.



Gradually and slowly turn to position 0.

2.) Gradual release of pressure:

Slowly turn the pressure regulator valve from position 2 to position 1 and wait for a few seconds. Then gently turn the valve further to steam release position 0. From position 1 you can turn directly to pressure release position 0 .



**WARNING:** The escaping steam is extremely hot. The steam escapes vertically, so do not hold your hands above the valve. Wait until all the steam has escaped, and the pressure indicator is no longer visible. This method is not suitable for foods which are mushy or tend to foam.

**WARNING:** Never use force to open the lid, and never interfere with the safety systems. The cooker can only be opened when it is no longer under pressure.

Clean your pressure cooker after every use with hot water and dishsoap. Do not use any scratching, abrasive or caustic cleaners, or any that contain chlorine. The pot can also be cleaned in the dishwasher without its lid. The lid should always be cleaned by hand.



## Cleaning and replacing the sealing ring:

To clean the sealing ring, rinse it under hot running water and dry it. As soon as the sealing ring becomes hard (when it begins to turn a brown color), it should be replaced.



## The safety lock pin:

Only needs (along with cleaning the lid) to be run through and rinsed with running water. It can also be tested clear by using a pointed object.



## Cleaning the pressure regulator valve:

Remove the plastic top. To do this, press the valve down and turn it completely to the left position.



The valve can now be lifted off and removed upward from its catch. Clean by running under water and reinsert into the catch.

Please ensure that the grooves on the valve are put into the appropriate holders.



You should store the pressure cooker after cleaning and drying it in a clean, dry and protected environment. Do not put the lid on and do not lock it, but store it with the lid upside down on the top of the pot, for example.

## Please note:

The pressure cooker's lid is not dishwasher safe.

When it takes a long time to come to the boil:

- The source of heat is not hot enough
- Turn up the source of heat to maximum

If the red pin does not rise, and steam does not escape from the valve during cooking:

- This is perfectly normal in the first few minutes (pressure build-up stage)
- If this persists, check whether:
  - The source of heat is hot enough; if not, turn it up
  - There is sufficient liquid in the cooker
  - The pressure regulator valve is not set at 0
  - The pressure cooker is properly shut
  - The sealing ring or the rim of the cooker is damaged



When the red pin has risen during cooking and steam is not escaping from the pressure regulator valve:

- Hold the pressure cooker under cold running water to release the pressure
- Open the pressure cooker
- Clean the pressure regulator valve and the safety valve

When the steam escapes from all around the lid, check:

- Whether the lid is properly closed
- Whether the sealing ring is properly fitted
- The condition of the sealing ring (if necessary, change it)
- Cleanliness of the lid, the safety valve, and the pressure-regulation valve
- That the rim of the cooker is in good working order

When the lid cannot be opened:

- Check whether the safety pin has dropped completely; if not, release the pressure
- If necessary, cool the pressure cooker off under cold running water

When the food being cooked is either not fully cooked or overcooked, check:

- The cooking time (too short or too long)
- The hotplate output
- That the pressure-regulation valve is correctly set
- The amount of liquid

When the food being cooked is burned on in the pot:

- Leave your pressure cooker to soak for a good time before cleaning it
- Do not use any caustic cleaners, or cleaners containing chlorine

When one of the safety devices is triggered:

- Turn off the source of heat
- Allow the cooker to cool down
- Open it
- Check the pressure regulator valve, the safety valve, and the sealing ring and clean them

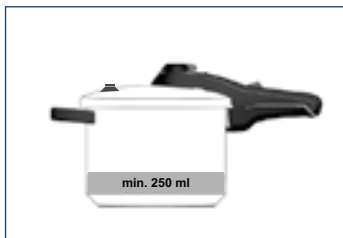

Every time you cook, always make sure that the correct amount of liquid is added – you must never “cook dry”. Please ensure that the cooker is never filled more than 2/3 full.

Please read the corresponding instructions in the Instructions for Use.

Different cooking times will also depend on the quality and size of the food to be cooked. For this reason, the times given in the cooking time section are only approximate.

With time, you will accumulate enough experience yourself to know exactly how long you must cook your food.

It is not necessary to defrost frozen foods in advance. It is sufficient to lengthen the cooking times slightly.

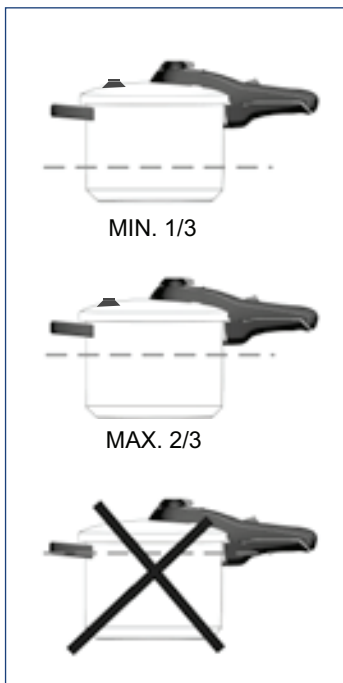

Soups and stews with braised meat:

Where cooking times of the different ingredients do not vary too much (e.g. for meat and vegetables), the meat is browned and then the vegetables are added with the water. When cooking times vary widely, interrupt the meat cooking and add the vegetables and water for the last few minutes. In this way, the meat and the vegetables will finish cooking at about the same time.

For soups and stews you should note: that foods which tend to foam up must be brought to the boil in an uncovered pressure cooker, and should be skimmed off before you close the cooker. When cooking is finished, let the steam escape slowly, or leave the pressure cooker to cool down.

SOUPS	COOKING TIME	FAST COOK
Bean soup	20 min	2
Pea soup (not soaked)	20–25 min	2
Vegetable soup	4–8 min	2
Potato soup	5–6 min	2
Minestrone	8–10 min	2
Rice soup	6–8 min	2
Boiling chicken	25–35 min	2
Tomato soup with rice	6–8 min	2

STEWES	COOKING TIME	FAST COOK
Cabbage stews	15 min	2
Lentil (soaked)	13–15 min	2
Beef	15 min	2

VEGETABLES	COOKING TIME	GRADUAL COOK
Cauliflower	3–7 min	1
Peas	3–5 min	1
Carrots	3–7 min	1
Onions	10–15 min	1
Mushrooms	6–8 min	1
Cabbage	5–15 min	1
Spinach	3–4 min	1

		FAST COOK
Beans	6–10 min	2
Potatoes	6–8 min	2
Potatoes (unpeeled)	6–12 min	2
Celery	12–15 min	2

Vegetables:

The finer the vegetables are cut up, the shorter their cooking time will be.

On the other hand, if you prefer them crunchy, their cooking time is shorter. The more vegetables you cook, the longer the cooking time will be. Suggestion: it is better to undercook because extra cooking is always possible.

MEAT	COOKING TIME	FAST COOK
Pork	30-40 min	2
Chicken	20-25 min	2
Veal, sliced	6 min	2
Veal, roast	15-20 min	2
Turkey	25-35 min	2
Beef	40-50 min	2
Pork shoulder	25-35 min	2
Braised marinated beef	30-35 min	2
Roast pork	25-30 min	2

#### Meat:

Meat is brought to boil in the uncovered pressure cooker. The necessary liquid is then topped up on deglazing. Pieces which are too large should be cut up and browned individually, then laid over one another to complete cooking.

FISH	COOKING TIME	GRADUAL COOK
Tilapia	6-8 min	1
Salmon	6-8 min	1
Cod	4-6 min	1
Perch	6-8 min	1

#### Fish (fresh):

Cook with adequate liquid, according to amount. Since fish stock is extremely sticky, the lid should be removed as soon as the pressure indicator has completely disappeared.

#### Frozen food:

The otherwise long times needed for defrosting shrink to minutes, but still depend on type and amount of the food to be defrosted. Defrosting in the pressure cooker preserves the vitamins, minerals and flavors of your food.



**kochstar**<sup>®</sup>  
Made in Germany

## WARRANTY

The pressure cooker is manufactured from top quality stainless steel and if looked after and used properly, will virtually last a lifetime. We hereby guarantee that the pressure cooker is free of material and manufacturing faults. The materials used comply with the highest quality requirements, and the manufacture of these pressure cookers is strictly controlled. If any repair which can be traced to a fault in manufacture or material is necessary within two years, this will be carried out free of charge.

## IMPORTANT!

When any parts are replaced, only our own ORIGINAL spare parts designed for this pressure cooker may be used.

If repairs are necessary, please contact our customer service department. Repairs may only be undertaken by authorised repairers.

*If you order spare parts, please state:*

**MODEL: SKT Email**



 Quality  
Made in  
Germany



**kochstar**<sup>®</sup>  
Made in Germany



Umformtechnik Merten & Storck GmbH  
Am Ladestrang 1 | D – 48317 Drensteinfurt | Germany  
Telefon: +49-2508-9909-0 | Telefax: +49-2508-9909-50  
E-Mail: [info@kochstar.de](mailto:info@kochstar.de) | [www.kochstar.de](http://www.kochstar.de)